

ARRAY 系列

3A3 Pro UPS

使用手册



Powering Business Worldwide

感谢您使用本公司产品！

请严格遵守本手册中和机器上的所有警告及操作说明并妥善保管本手册。在没有阅读完所有的安全说明和操作说明以前，请不要操作 UPS。

严正声明

监管码声明

为了切实保障您的消费权益和用电安全，请注意以下事项：

- 1、每一台 ARRAY 3A3 Pro 机身上均贴有“电子监管码”（“电子监管码”是国家质检总局为打击假货推行的一种产品身份识别码）。
- 2、消费者可以通过以下途径对产品电子监管码进行查验，并可通过“中国产品质量电子监管网”平台进行投诉、举报。

查询方式：

网站查询：登陆 www.95001111.com（中国产品质量电子监管网），输入监管码进行查询；

电话查询：95001111 进行查询（未开通地区可拨打 010-95001111）；

短信查询：将监管码发送至 106695001111（移动、联通均可）；

如有疑问，可以拨打电话 95001111 或登陆 www.95001111.com 点击“消费者通道”进行举报投诉。

版权声明

本公司致力于技术创新，不断提供更好的产品和服务满足客户需求，对产品设计、技术规格的更新，恕不另行通知。产品以实物为准。

请登陆网站 www.eaton.com/powerquality 下载最新版的产品说明书。

版权所有 ©2013 伊顿电源（上海）有限公司

安全注意事项

操作安全

1. 在使用本产品前，请仔细阅读“安全注意事项”，以确保正确和安全的使用。并请妥善保存说明书。
2. 操作时，请注意所有警示标记，并按要求进行操作。
3. 避免在阳光直接照射、雨淋或在潮湿的环境使用本设备。
4. 本设备不能安装在靠近热源区域，或有电暖炉、热炉等类似设备的附近。
5. 放置 UPS 时，在其四周要留有安全距离，保证通风。安装时，请参照说明书。
6. 清洁时，请使用干燥的物品进行擦拭。
7. 若遇火警，请正确使用干粉灭火器进行灭火。若使用液体灭火器会有触电危险。
8. 安装前要考虑楼层对机器和电池组的承重能力。
9. 使用脚轮运输机柜时，请事先将机柜内的所有 UPS 模块拉出，插入 UPS 模块时必须使用调平底座承重（请勿使用脚轮承重）。

电气安全

1. 上电前，请确认已正确接地，并检查接线和电池极性的连接正确。
2. 当 UPS 需要移动或重新接线时，应将交流输入电源断开，并保证完全 UPS 停机，否则输出端仍可能带电，有触电的危险。
3. 请使用 Eaton 指定的附加装置和附件。

电池安全

1. 电池的寿命随环境温度的升高而缩短。定期更换电池可保证 UPS 工作正常，并保证足够的后备时间。
2. 蓄电池维护只能由具备蓄电池专业知识的人员来进行。
3. 更换蓄电池，必须使用相同类型和型号的蓄电池，且数量必须相同。
4. 蓄电池存在电击危险和短路电流危险。为避免触电伤人事故，在更换电池时，请遵守下列警告：
 - A. 不要佩带手表、戒指或类似金属物体；
 - B. 使用绝缘的工具；
 - C. 穿戴橡胶鞋和手套；
 - D. 不能将金属工具或类似的金属零件放在电池上；
 - E. 在拆电池连接端子前，必须先断开连接在电池上的负载。
5. 请不要将蓄电池暴露于火中，以免引起爆炸，危及人身安全。
6. 非专业人士请勿打开或损毁蓄电池，因为电池中的电解液含有强酸等危险物质，会对皮肤和眼睛都会造成伤害。如不小心接触到电解液，应立即用大量的清水进行清洗，并去医院检查。
7. 请不要将电池正负极短路，会导致电击或着火。

使用保养

1. 使用环境及保存方法对本产品的使用寿命及可靠性有一定影响，因此，请注意避免在下列工作环境中使用：

- a. 超出技术指标规定（温度 0-40℃，相对湿度 20-90%）的高、低温和潮湿场所；
- b. 有振动、易受撞的场所；
- c. 有金属性粉尘、腐蚀性物质、盐份和可燃性气体的场所。







2. 如果长时间放置不使用，必须将 UPS（不带电池）存放在干燥的环境中，存贮温度范围：-25-55℃。UPS 开机之前，必须先让环境温度回暖至 0℃ 以上，并维持一段时间。

目 录

第一章 简介	01
第二章 包装拆卸说明	03
第三章 UPS 外观图	05
第四章 UPS 安装	08
第五章 电气安装	11
第六章 在线增减、更换 UPS 模块	16
第七章 运行操作	18
第八章 菜单命令	21
第九章 UPS 维护	31
第十章 通讯界面	33
第十一章 常见问题处理	35
第十二章 产品规格	37
第十三章 维修保证	39
附录一 灯号参照表	40
附录二 电池配置	41

第一章 简介

1.1 常用符号说明

符号及含义	
符 号	含 义
	注意安全
	当心触电
	交 流
	直 流
	保护接地
	重复循环
	勿与杂物一同放置

1.2 手册适用对象

本手册只适用于 ARRAY UPS 系列的 3A3 Pro UPS。

1.3 产品简介

3A3 Pro UPS 属于 ARRAY UPS 系列，是高效率、高性能的双转换纯在线式 UPS 产品。与其它 ARRAY UPS 系列产品一样，采用抽屉式高智能模块化设计，一个 UPS 模块就是一台功能齐全的三进三出的 UPS。用户可以通过增减机内 UPS 模块来满足功率输出及可靠性要求，达到最佳性价比。

3A3 Pro UPS 由 UPS 机柜、UPS 模块、配电盘（选配件）、防尘模块（选配件）、防雷模块（选配件）组成。UPS 系统采用的是标准 19 英寸 2 米机柜，最多可以安装十个抽屉式 UPS 模块，在输出功率允许的情况下，整机可在一至十个模块下正常运行，且能在不影响其它 UPS 模块工作的情况下方便地进行模块增减或更换。单个 UPS 模块的容量为 15kVA，安装十个 UPS 模块时 UPS 总容量达到 150kVA。由于 UPS 机柜空间的限制，UPS 模块数量、配电盘数量根据实际情况选取，增加其中一项（或增加数量）便要舍弃其中一项（或减少数量），具体事宜请参考其它相关资料。

3A3 Pro UPS 利用功能强大的通讯模块通过机内网络收集各 UPS 模块信息，并对各 UPS 模块的工作进行集中监控，所有信息由 7 英寸超大彩色触摸屏显示，使得 UPS 的使用操作简单明了。

3A3 Pro UPS 可以解决几乎所有的电力问题，如电涌、高压突波、暂态过电压、电压下陷、噪声干扰、频率漂移、谐波、电压过低、市电中断等。本系列产品产品适用范围广泛，从计算机设备到通信系统以及自动设备都可以使用。

1.4 产品标准

3A3 Pro UPS 产品符合下列等级标准

EMC:	EMI	EMS	
	IEC 62040-2:2005 C3 GB 7260.2(I>25A)	IEC : 61000-4-2(ESD) 61000-4-3(RS) 61000-4-4(EFT) 61000-4-5(SURGE)	GB/T17626.2 静电放电抗扰度 GB/T17626.3 射频电磁场辐射抗扰度 GB/T17626.4 电快速瞬变脉冲群抗扰度 GB/T17626.5 浪涌（冲击）抗扰度

警告：如本产品用于 C2 环境中，应采取附加措施进一步抑制电磁干扰。

安规：GB 4943.1-2011 信息技术设备安全第 1 部分：通用要求
YD/T 1095-2008 通信用不间断电源 -UPS

1.5 热线电话

如果您有任何问题，请拨打 EATON 的服务热线电 400-889-3938，我公司客服人员将为您提供 24 小时不间断的服务响应。

第二章 包装拆卸说明

2.1 机柜拆卸说明

注意：请检查包装是否在运输过程中损坏，如发现损坏请勿继续操作，请通知承运商与经销商。检查随机附件：使用手册一本，螺丝与绑线附件一份，机柜钥匙两把。

1. 拆顶盖，用剪刀剪断打包带，取下顶盖（图 2-1）。
2. 拆侧板，用老虎钳将侧板的插舌掰直，取下四周侧板（图 2-2）。
3. 移走箱体上方及四周的填充物及胶袋（图 2-3）。
4. 用扳手下卸机柜底部固定支脚的螺丝并调节固定支脚的高度（图 2-4）。
5. 利用包材斜坡板，前后至少各一人协作将箱体小心推至地面（图 2-5）。

注意：搬运之前先确认门及通道内其他障碍物的高度。



图 2-1



图 2-2

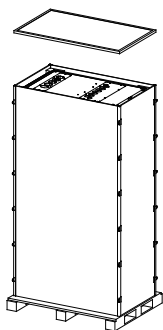

图 2-3

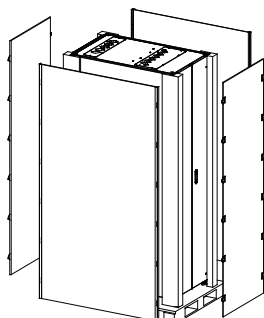

图 2-5

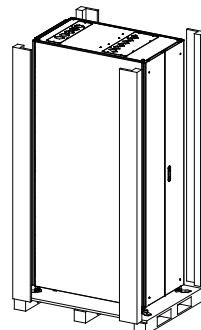

图 2-4

2.2 模块包装拆卸说明

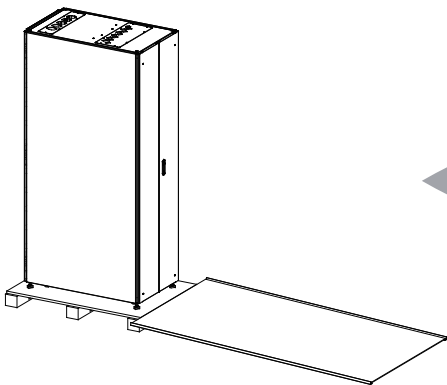
1. 切断包装带，打开纸箱（图 2-6）；
2. 向上移走 UPS 模块上方填充物（图 2-7）；
3. 取出 UPS 模块（图 2-8）；

注意：UPS 模块较重，需要两人搬运操作。

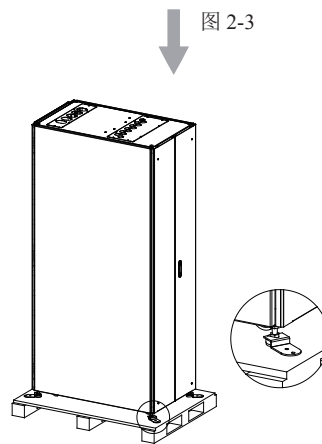

图 2-6



图 2-7

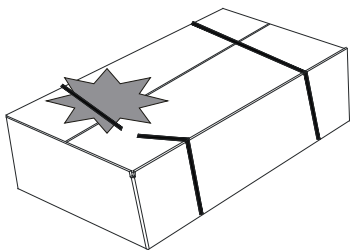

图 2-8

第三章 UPS 外观图

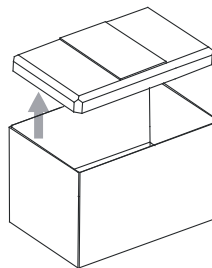
3.1 UPS 机柜外观图

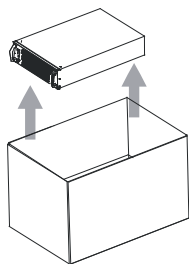

图 3-1 前视图



图 3-2 上出线机柜顶视图 (右图含束线架)

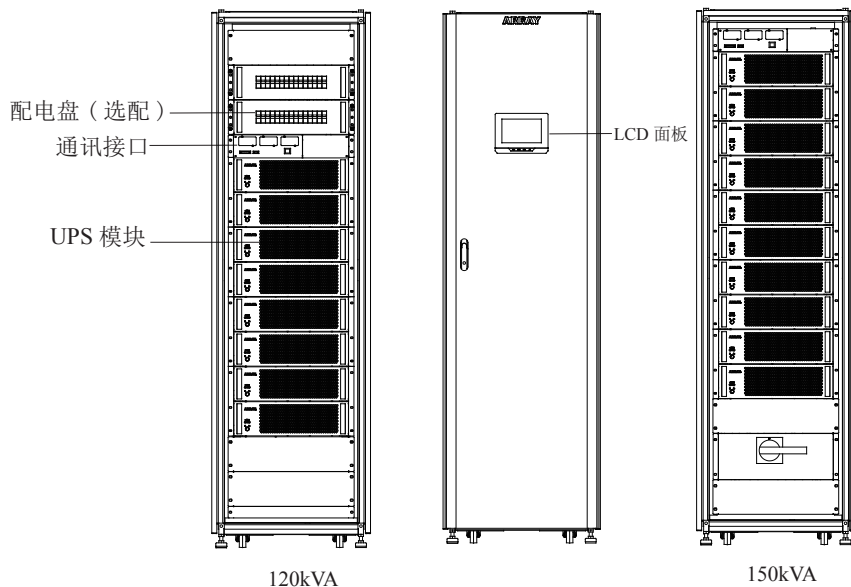

图 3-3 120K 上出线机柜后视图

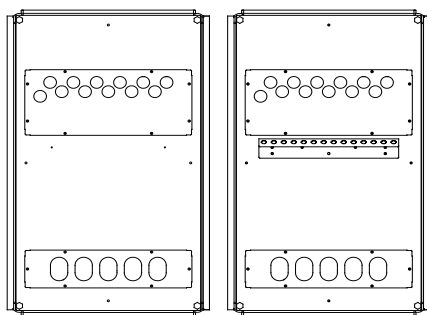

图 3-4 120K 下出线机柜后视图

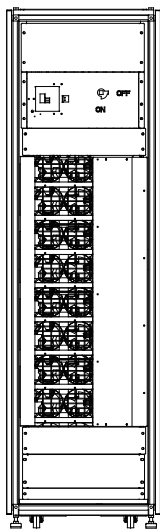

图 3-5 150K 后视图

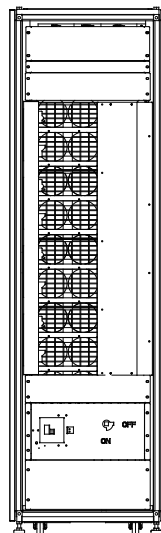

图 3-6 150K 下出线机柜后视图

3.2 UPS 模块外观图

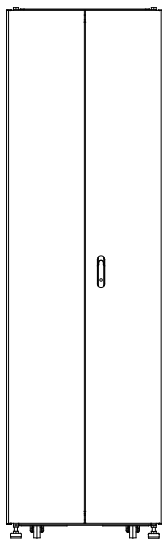

图 3-7 模块前视图

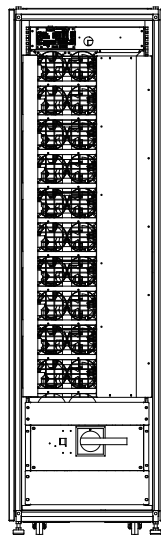

图 3-8 模块后视图

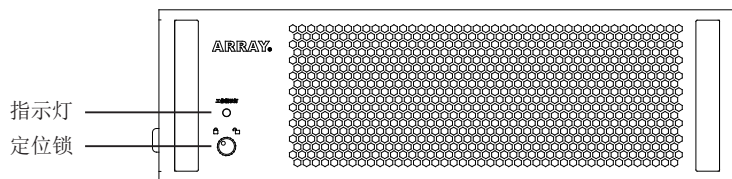

图 3-9 模块顶视图

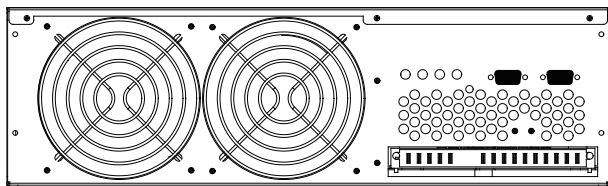

图 3-10 配电盘模块模块前视图

第四章 UPS 安装

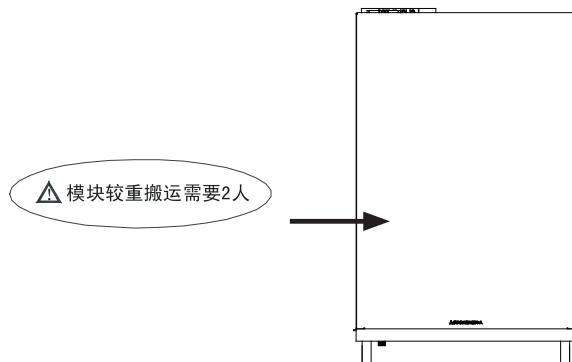
4.1 安装需知

1. 请在干净、平稳的环境中安装 UPS，避开震动、灰尘、高湿、可燃性气体、可燃性液体或腐蚀性物质环境。
2. UPS 正常工作时的环境温度要求在 0-40℃ 之间。如果工作在 40℃ 以上的环境里，要求最大带载量按每增加 5℃，递减 12% 额定值实施。UPS 工作时的最高环境温度要求不超过 50℃。
3. 电池组建议在 15-25℃ 之间使用。
4. UPS 满载正常运行时的海拔高度不应高于 1000 米，如果在高海拔地区使用 UPS，请降额使用。各海拔高度正常运行对应的降额系数如下表所列：

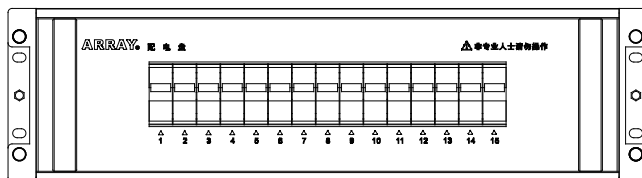
（高海拔地区正常运行最大负载 = UPS 标称功率 × 降额系数）

海拔 (M)	1000	1500	2000	2500	3000	3500	4000	4500	5000
降额系数	100%	95%	91%	86%	82%	78%	74%	70%	67%

5. 3A3 Pro UPS 采用风扇强制冷却，安装场地必须通风良好。UPS 前、后门板有网状通风口，不能有障碍物挡住门板。
6. 3A3 Pro UPS 采用正负电池架构，一组电池为 32-40 节电池串联，中间引出一条中线，加上首、尾的引出线一共有 3 条线与 UPS 接线排相连。电池组正端与电池组中线之间的电池称为正电池，电池组负端与电池组中线之间的电池称为负电池。（具体连接方式请参考接线原理图），您可以根据需要选择电池的容量和组数。当不同电池节数配置时，UPS 需降额使用，各电池节数与对应的降额系数如下表所列：

电池节数	40	38	36	34	32
降额系数	100%	95%	90%	85%	80%

7. 接线方式：3A3 Pro UPS 是三相输入、三相输出 UPS，输入配线必须接入三相火线及零线，输出可以根据负载情况接成不同的方式（ Δ 、Y 及其它方式），具体接线方式见接线原理图。
8. 配线标准：3A3 Pro UPS 采用模块化设计，可以根据负载量选择模块数量，为了使用安全以及方便扩容建议按最大负载量进行配线，用户也可以根据容量进行配线，本手册中给出了各种模块配置下线径的选择，供参考。

4.2 安装空间

为了机器风冷散热以及维护的方便，UPS 机柜前门与障碍物间必须有至少 1000mm 的距离 ($D1 \geq 1000\text{mm}$)，机柜后门距离障碍物至少有 800mm 的距离 ($D3 \geq 800\text{mm}$)（如图 4-1）。



图 4-1

4.3 安装步骤

1. 用套筒或扳手下卸栈板上的木螺丝，取下机柜固定支架并调节调平底座高度。
2. 将机柜推到预定位置后并用扳手调节调平底座至脚轮悬空。
3. 用固定支架固定调平支脚（使用 M8 地脚螺丝）（如图 4-2）。

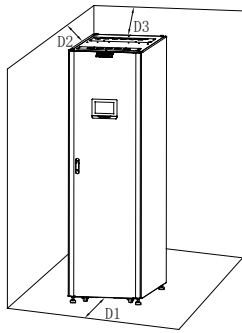

图 4-2

4. 拆掉 UPS 模块的包装，检查模块前面板上的定位锁的状态，正常情况定位锁上的白点应该对准“☐”位置（图 4-3）；如果白点对准“🔒”位置，请用手拧到“☐”位置。



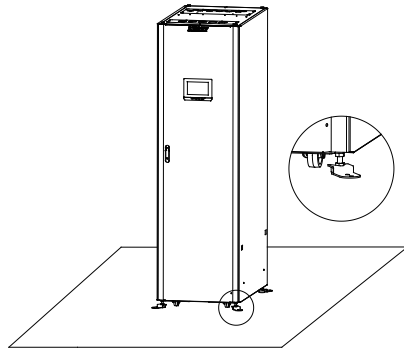

图 4-3

5. 将 UPS 模块装入到机柜的模块插槽内，沿着插槽将模块平推到机柜内直到模块完全插入到机柜内。
注意：模块较重，安装时需要两个人一起进行。
6. 将模块前面板的定位锁打到“”位置（图 4-4）；
7. 重复上述 4-6 的步骤将所需 UPS 模块依次全部安装到 UPS 机柜内（图 4-5）；
8. 安装配电盘模块（选配）：卸下配电盘安装位置的盲板，调整活动螺母的位置和配电盘的安裝孔保持一致，将配电盘使用 M6 内六角螺丝固定到预定位置（图 4-5）；
9. 配电盘接线：将配电盘后方的电缆按标识连接到 UPS 输出铜条的对应位置。

注意：

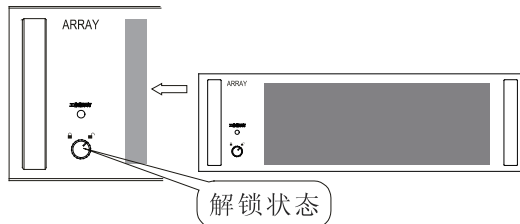
配电盘高度为 3U，2 个安装孔之间的距离 2U；

配电盘的安裝位置和进出线位置保持一致（机柜上进出线时配电盘置于机柜上方前侧，下进出线时置于机柜下方前侧）；



图 4-4



图 4-5

第五章 电气安装

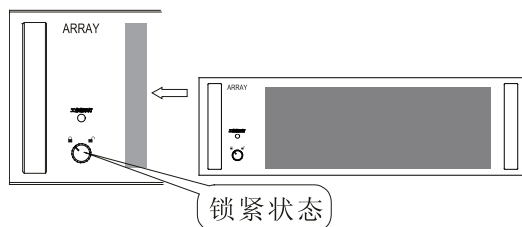
3A3 Pro UPS 电气部分的安装必须由经过培训的合格工程师依据“电工法则”与“3A3 Pro UPS 安装规范”进行，严禁其它人员违规进行安装，本手册只介绍安装的基本内容，具体安装细节请参考安装规范。

5.1 电力线选择

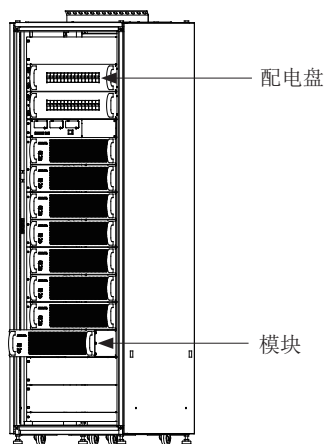
3A3 Pro UPS 机柜容量（可以容纳的 UPS 模块数）有四种可以选择，60kVA（最多容纳四个 UPS 模块）、90kVA（最多容纳六个 UPS 模块）、120kVA（最多容纳八个 UPS 模块）、150kVA（最多容纳十个 UPS 模块），电力线线径的选择应该在此基础上再考虑过载以及电网电压的因素进行，一般情况下建议用户按照机柜的最大容量选择电力线，以保证 UPS 在以后扩容时不需要另外再改线径，这样更能体现 3A3 Pro UPS 在线扩容的优点。

如果 UPS 模块实际安装的数量没有达到 UPS 机柜的容量，用户也可以根据实际使用情况选择电力线的线径，电力线的线径可以随着 UPS 模块数量的不同而不同，本手册根据不同的模块数给出了对应的电力线选择，供用户参考（详情见下表）

模块数	电力线选择									
	UPS 输入线				UPS 输出线				电池线	
	L		N		L		N		美标	国标
美标	国标	美标	国标	美标	国标	美标	国标			
1	12AWG	6mm ²	6AWG	16mm ²	12AWG	6mm ²	6AWG	16mm ²	12AWG	6mm ²
2	6AWG	16mm ²	6AWG*2	16mm ² *2	6AWG	16mm ²	6AWG*2	16mm ² *2	6AWG	16mm ²
3	4AWG	25mm ²	4AWG*2	25mm ² *2	4AWG	25mm ²	4AWG*2	25mm ² *2	4AWG	25mm ²
4	6AWG*2	16mm ² *2	2AWG*2	35mm ² *2	6AWG*2	16mm ² *2	2AWG*2	35mm ² *2	6AWG*2	16mm ² *2
5	4AWG*2	25mm ² *2	4AWG*3	25mm ² *3	4AWG*2	25mm ² *2	4AWG*3	25mm ² *3	4AWG*2	25mm ² *2
6	4AWG*2	25mm ² *2	2AWG*3	35mm ² *3	4AWG*2	25mm ² *2	2AWG*3	35mm ² *3	4AWG*2	25mm ² *2
7	4AWG*2	25mm ² *2	2AWG*3	35mm ² *3	4AWG*2	25mm ² *2	2AWG*3	35mm ² *3	4AWG*2	25mm ² *2
8	2AWG*2	35mm ² *2	2AWG*3	35mm ² *3	2AWG*3	35mm ² *3	2AWG*3	35mm ² *3	2AWG*3	35mm ² *3
9	2AWG*3	35mm ² *3	4/0AWG*2	95mm ² *2	2AWG*3	35mm ² *3	4/0AWG*2	95mm ² *2	2AWG*3	35mm ² *3
10	1/0AWG*2	50mm ² *2	4/0AWG*2	95mm ² *2	1/0AWG*2	50mm ² *2	4/0AWG*2	95mm ² *2	1/0AWG*2	50mm ² *2

注意：

1. 本表格的线径选择是结合保护元件根据理论上最大的电流进行选取。
2. *n(n 为数字) 表示需要 n 股相同的线，例：“2AWG*3”表示需要 3 根 2AWG 线。
3. 地线线径规格需和 N 线一样。

5.2 开关及保护元件选择

3A3 Pro UPS 机柜中自带开关，3A3 Pro UPS 机柜中输出只接有开关，不带保护元件。用户在安装 3A3 Pro UPS 时需要在 UPS 输入与输出外接开关及保护元件，建议选用“无熔丝断路器（NFB）”代替传统的开关与保险丝组合件。

NFB 的选择需同时考虑电压规格与电流规格，用户可以根据负载情况进行选择，因为 NFB 是保护元件，建议按 UPS 的实际容量进行选择，否则起不到应有的保护作用。本手册根据 UPS 模块的数量列出了 NFB 的需求情况，供用户在安装时参考（详情见下表）。

UPS 模块数	UPS 输入 NFB	UPS 输出 NFB	电池 NFB
	电流 / 电压	电流 / 电压	电流 / 电压
1	3φ 40A/ 250VAC	3φ 40A/ 250VAC	3φ 40A/ 500VDC
2	3φ 80A/ 250VAC	3φ 80A/ 250VAC	3φ 80A/ 500VDC
3	3φ 120A/ 250VAC	3φ 120A/ 250VAC	3φ 120A/ 500VDC
4	3φ 160A/ 250VAC	3φ 160A/ 250VAC	3φ 160A/ 500VDC
5	3φ 200A/ 250VAC	3φ 200A/ 250VAC	3φ 200A/ 500VDC
6	3φ 240A/ 250VAC	3φ 240A/ 250VAC	3φ 240A/ 500VDC
7	3φ 280A/ 250VAC	3φ 280A/ 250VAC	3φ 280A/ 500VDC
8	3φ 320A/ 250VAC	3φ 320A/ 250VAC	3φ 320A/ 500VDC
9	3φ 360A/ 250VAC	3φ 360A/ 250VAC	3φ 360A/ 500VDC
10	3φ 400A/ 250VAC	3φ 400A/ 250VAC	3φ 400A/ 500VDC

注意：UPS 输入、输出 NFB 建议选择 3 极（3 极连动），电池 NFB 建议选择 3 极（3 极连动）（具体安装参考 5.3、5.4 节）。

5.3 电力线配线原理图



图 5-1 电力线配线原理图

说明:

1. UPS 输入 N 线必须正确连接。

2. 3A3 Pro UPS 一组电池为 32-40 节电池串联，以 40 节电池为例进行说明，中间（第二十节电池与第二十一节电池相联处）引出一条中线，加上首、尾的引出线一共有 3 条线与 UPS 接线排相连。电池线引出必须经过一个直流断路器才能接到 UPS 对应的接线排上，具体接线请参考下图：

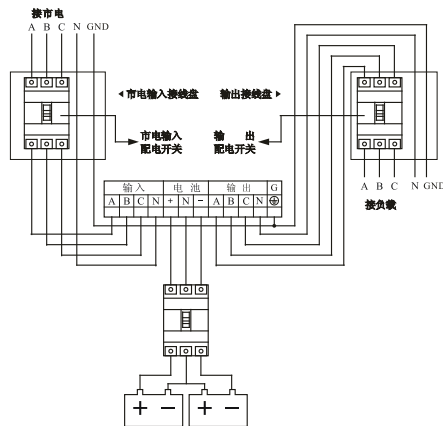

图 5-2 电池连接示意图

注意：由于电池有三条引出线，与 UPS 接线时注意按标识正确接入，否则有造成电池短路的危险，接线前要进行二次检查；同时串联的电池数量较多，要使用安规电压符合要求的直流断路器。

5.4 安装说明

1. 接线位置

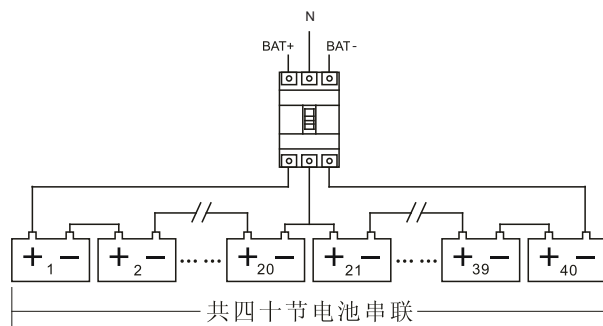

图 5-3 上出线机柜接线位置图（拆掉出线盖板）



图 5-4 下出线机柜接线位置

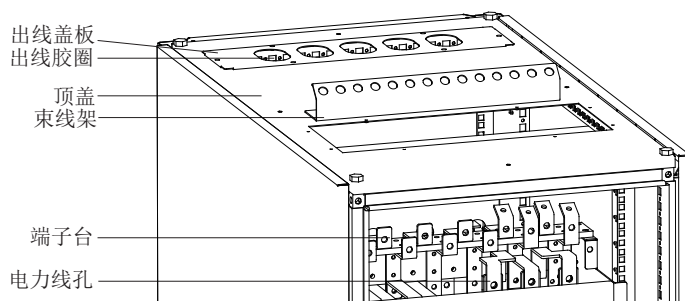

图 5-5 UPS 机柜在底部预留配电盘走线位置

2. 电力线安装图解

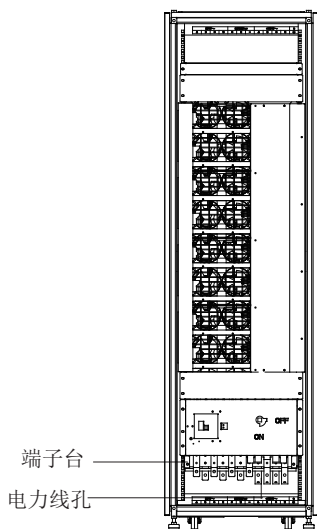
上出线机柜接线方式

- 1) 拆下正面的端子排盖板（图 5-6）。
- 2) 将 UPS 输入、输出配线和电池配线穿过顶部出线盖板上的出线胶圈按标识在正面方向接到对应的铜条上（铜条上的标识如图 5-7）。
- 3) 将端子排盖板用螺丝固定到原位。
- 4) 用绑线将电力线固定在束线架上。

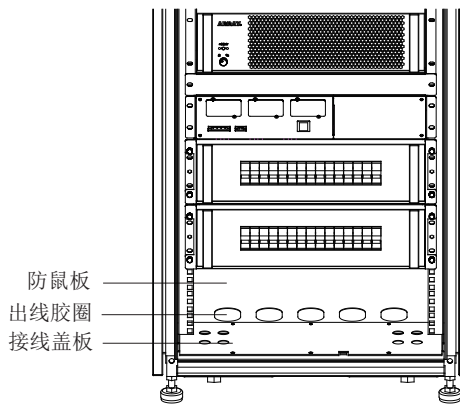

图 5-6



图 5-7

下出线机柜接线方式

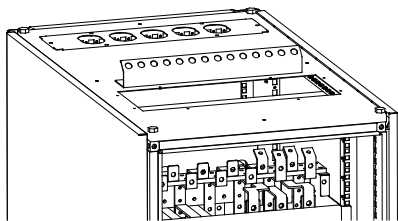
- 1) 拆下正面的端子排盖板和底部的接线盖板（图 5-8）。
- 2) 将 UPS 输入、输出配线和电池配线穿过防鼠板上的出线胶圈，按标识接到对应的铜条上（铜条上的标识如图 5-9）。
- 3) 将端子排盖板和底部的接线盖板用螺丝固定到原位。

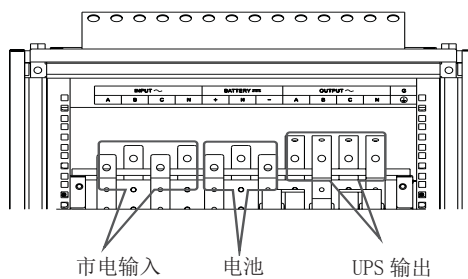

图 5-8



图 5-9

注：容量为 150kVA 的机柜下出线接线方式

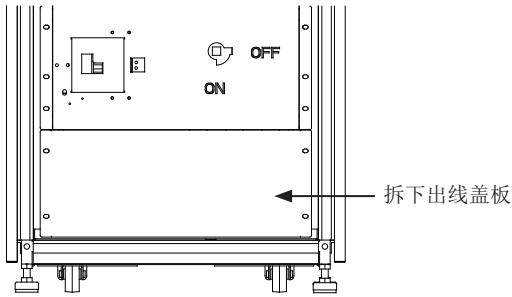
- 1) 拆下机柜后面的端子排盖板和底部的接线盖板。
- 2) 将市电输入和电池配线穿过防鼠板上的出线胶圈，按标识接到对应的铜条上（铜条上的标识如图 5-10）。
- 3) 拆下机柜正面的端子排盖板，将 UPS 输出配线按标识连接到对应的铜条上（铜条上的标识如图 5-11），接线之前必须先确认地线已接。
- 4) 将端子排盖板和底部的接线盖板用螺丝固定到原位。

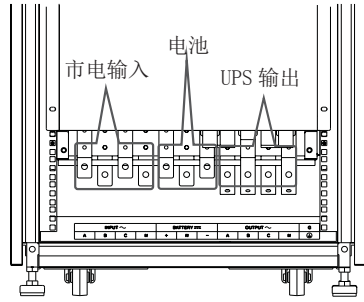

图 5-10



图 5-11

第六章 在线增减、更换 UPS 模块

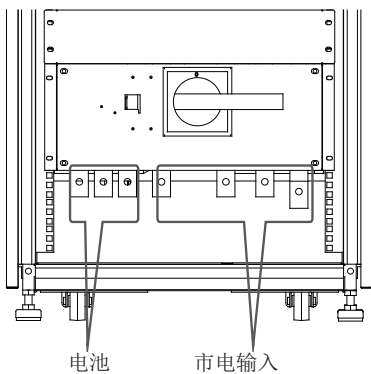
N+X 是目前最可靠的供电结构，N 代表总负载所需的最少 UPS 数，X 代表的是冗余的 UPS 数，也就是系统可以同时承受的故障模块数，X 越大，系统的可靠度就会越高。3A3 Pro UPS 是实现 N+X 供电系统的最佳选择，3A3 Pro UPS 机柜最多可以安装 10 个 UPS 模块，N+X 并联冗余系统可以配置成 1+9 至 9+1 等多种不同的方式。3A3 Pro UPS 可以在线增加、减少、更换 UPS 模块，可以按使用需求随时更改 N+X 并联冗余系统的 N 与 X 的数量，当 UPS 模块发生故障时，只要故障的 UPS 模块数小于等于 X，则可以在不影响 UPS 运行的情况下在线更换故障的 UPS 模块。

6.1 N+X 并联冗余系统的选择

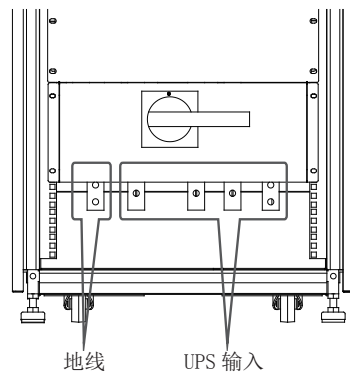
3A3 Pro UPS 机柜最多可以安装 1-10 个 3A3 Pro UPS 模块，用户可以很方便的选择 N+X 的并联冗余方案，假设负载容量为 25kVA，可以选择的方案参见下表。

N+X	允许最大功率		允许故障 UPS 模块数
	视在功率 (kVA)	有用功率 (kW)	
2+0	30	27	0
2+1	30	27	1
2+2	30	27	2
2+3	30	27	3
2+4	30	27	4
2+5	30	27	5
2+6	30	27	6
2+7	30	27	7
2+8	30	27	8

注意：

- 1) “允许最大功率”并不是说超过这个功率 UPS 就会过载，当用户选择 2+2 的冗余方案，可带载的视在功率为 60kVA，有用功率为 54kW，因此，如果用户负载 >27kW 时（允许最大功率），UPS 不会过载，只是改变了 X=2 的冗余模块数。
- 2) “允许最大功率”指的是三相功率，单相允许最大功率要除以 3。

6.2 UPS 模块在线增减、更换

3A3 Pro UPS 支持在线插、拔 UPS 模块，但是这个过程必须按照一定的程序执行，在线增减、更换 UPS 模块时必须严格按照使用说明操作。

1. 在线拆卸 UPS 模块

- 1) 将需要拆卸的 UPS 模块前面板的定位锁打到“”（图 6-1）；将模块后面的输入开关打到 OFF 位置；（图 6-2）。
- 2) 两个人分别用一只手拉住 UPS 模块前面板上的拉手、一只手托住 UPS 模块底部，两人同时用力缓慢往外平拉，模块拉出后两人合力拖住模块轻放在地面或其它暂放台上。



图 6-1



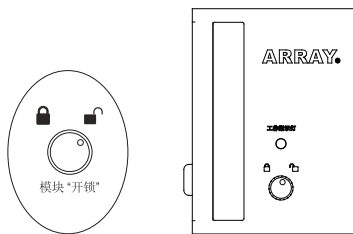

图 6-2

2. 在线增加 UPS 模块

- 1) 拆掉机柜上需安装模块位置的挡板。
- 2) 两个人分别用一只手抓住 UPS 模块前面板上的拉手、一只手托住 UPS 模块底部合力将 UPS 模块沿着机柜上安装模块的插槽平推到插槽内。
- 3) 将模块前面板的定位锁打到“”（图 6-3）。
- 4) 将模块后面的输入开关打到 ON 位置（图 6-2）。

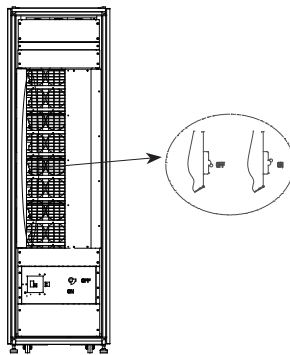

图 6-3

- 5) 如果在市电模式下加入 UPS 模块，新加入的 UPS 模块会自动加入并机系统；如果在电池模式下加入 UPS 模块，在完成上述四个步骤后，需按电池冷启动开关，新加入的 UPS 模块才会建立电源并加入并机系统。

第七章 运行操作

7.1 LCD 界面

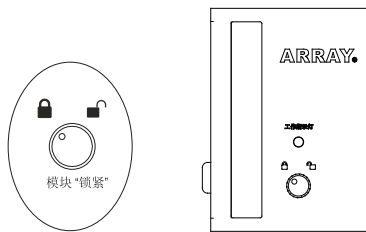
LCD 显示屏位于机柜的前部，通过触摸操作，可以方便地了解 UPS 的信息。

LCD 显示分为二个区域：UPS 状态栏、数据信息显示区。UPS 状态栏通过颜色的不同向用户提供基本的 UPS 状态信息；数据信息显示区通过 LCD 显示屏向用户提供详细的 UPS 信息；



图 7-1

7.1.1 状态栏

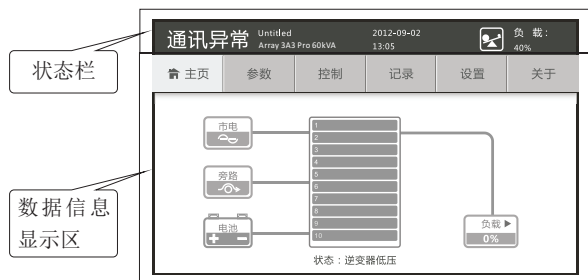

图 7-2

①系统状态：

显示机器目前状态。

②机器名称：

机器名称由客户自定义，如客户有多个机柜可通过设置名称来区别。

③机器型号与容量：

显示机器型号 Array 3A3 Pro xxKVA，容量根据模块数自动显示。

④系统时间：

显示通讯卡 (CSB) 中的系统时间。

⑤参数信息：

显示三种参数信息：输出电压和频率、负载、电池容量。正常情况下，只有输出电压和频率、负载滚动显示，滚动间隔时间为 3s。当系统转为电池模式并且电池容量低的时候，只显示电池容量，不再滚动显示其它信息。

6) 状态栏颜色:

状态栏颜色	说明
蓝色	系统所处的模式: 关机、待机、市电、变频、电池 (电池容量充足)、电池自检 (电池容量充足)。
橙色	系统所处的模式: 旁路、电池 (电池容量低)、电池自检 (电池容量低)
红色	系统故障, 状态栏在红色与浅蓝之间闪烁, 点击感叹号标志可进入当前事件界面查看状态信息。

7.2 开机操作

注: 开机前请检查 UPS 输入、输出、电池连线是否正确无误, 如果不对请参考说明书重新进行配线, 确认无误后再执行下面的操作。

1. 正常开机操作 (市电正常, 有无电池都可)

1) 确认机柜后面对应位的模块市电输入开关处于“ON”状态 (图 6-2)

2) 检查已安装的 UPS 模块的前面板上的定位锁, 确认所有模块的定位锁都处于“”状态 (图 7-3)。



图 7-3



图 7-4

3) 合上电池开关 (开关外接)。

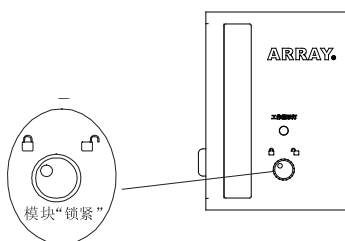
4) 合上市电输入开关 (开关外接)。

5) 若在无市电情况下开机, 需反复开关通讯界面中的“冷启动开关” (图 7-4), 系统冷启后约 1 分钟后自动进入主页。

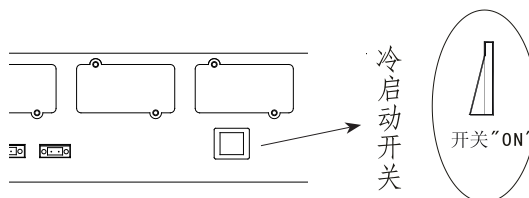
①进入主页, 点击“控制”按钮进入登录界面, 输入正确的控制密码或用户密码, 点击 ENTER 键后, 再点击“进入”按钮进入系统控制界面;



若控制密码设置为使能状态, 进入系统控制界面需要输入密码。初始的控制密码、用户密码分别为: 1111、1234。

若控制密码设置为禁止状态, 在主页菜单栏点击“控制”按钮则直接进入系统控制界面。

②在系统控制界面点击“开机”按钮”，弹出确认提示框。点击确认后，若系统满足开机条件，开机成功，开机按钮变为绿色。



若系统不满足开机条件，弹框显示禁止操作的提示信息，显示的信息如下：

按钮	禁止操作的提示信息
开机	1. 未插入 UPS 模块或 UPS 模块未上电，禁止开机！
	2. 紧急断电（EPO）开关使能，禁止开机！
	3. 模块未锁或开机开关未闭合，禁止开机！
	4. 维护盖板打开，禁止开机！

7.3 关机操作

①进入主页，点击“控制”按钮进入登录界面，输入正确的控制密码或用户密码，点击 ENTER 键后，再点击“进入”按钮进入系统控制界面：



若控制密码设置为使能状态，进入系统控制界面需要输入密码。初始的控制密码、用户密码分别为：1111、1234。

若控制密码设置为禁止状态，在主页菜单栏点击“控制”按钮则直接进入系统控制界面。

②选择“关机到旁路”后由旁路为负载供电，“旁路按钮”变为橙色。

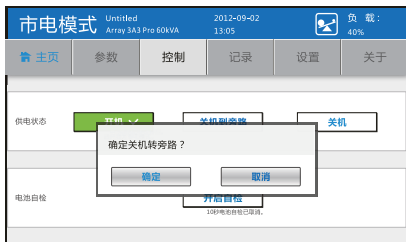

若系统不满足关机条件，弹框显示禁止操作的提示信息，显示的信息如下：

按钮	禁止操作的提示信息
关机转旁路	1. 变频模式下禁止转旁路！
	2. 旁路异常禁止转旁路！

③选择“关机”，10 秒后提示“UPS 已关机”。若系统已处于关机状态点击关机按钮，则弹框提示“UPS 未开机！”



第八章 菜单命令

8.1 菜单命令功能说明

菜单列表	描述
主页	显示菜单栏和系统状态模拟图信息。
参数	用于查看的参数类型：系统参数、模块参数、电池参数。
控制	提供电源控制命令。控制 UPS 开机、关机和电池自检。
记录	通过“记录”可查看 UPS 当前和历史的告警故障信息，还可以进行清除历史记录。
设置	用于对 UPS 进行设置和维护。
关于	供用户和维护人员查看各模块软件版本号，系统信息，同时提供维护时间提醒。

子菜单项目		功能描述	
参数	系统参数	显示三相输入 / 旁路 / 输出的电压及频率参数。	
	模块参数	显示每个模块当前状态，模块颜色所对应的状态与主页显示的模块状态一致。	
	电池参数	显示正负电池的状态、电压、电流、容量。 在“设置”->“服务”->“电池配置”中将电池电流侦测设为禁止，则在电池参数界面无电池电流内容。	
控制	系统控制	对 UPS 系统的运行状态进行切换以及对电池进行自检，包含：开机、关机转旁路、关机、电池自检。	
记录	当前事件	显示系统当前事件信息。显示项：事件 ID、名称、类型。	
	历史记录	显示系统历史事件信息。显示项：时间、事件 ID、名称、来源、类型；进入需输入服务密码。	
	清除记录	输入服务密码可清除所有事件记录。	
设置	配置	语言选择	设定语言类型简体中文、English。
		机器名称	设置机器名称限 14 个字符，键盘采用系统自带的文本键盘。
		时间设置	设定 UPS 系统 LCD 面板显示日期和时间。
		电池自检	通过电池自检获得电池信息。
		屏保时间	设置屏保时间，超过设置范围无动作则关掉背光灯，进入屏保状态。
		灯光测试	进行灯光测试。
		LCD 背光灯	设置 LCD 背光灯亮度。
		控制密码	设置控制密码为禁止或使能状态，进行密码修改。
		配置密码	设置配置密码为禁止或使能状态，进行密码修改。
	联系客服	设置客服的电话号码，最多可输入 13 个数字。	
服务	电池设置	电池配置：对电池的型号、组数、节数、温度补偿、电池电流侦测进行设置。 需在待机模式或旁路模式下才可进入。	
		电池充电：通过开启或关闭 10 个模块的充电器来控制充电电流。	
		电池放电：设置电池放电时的低压告警值（单节电池电压：10.5~11.3V）。 需在待机模式或旁路模式下才可进入。	

子菜单项目		功能描述	
设置	服务	输出设置	对系统输出电压、输出频率进行设置。 1. 只能在待机模式或旁路模式下设置； 2. 若系统模式已设置为变频模式，则禁止设置频率。
		旁路设置	显示当前或设置后的旁路上限电压、下限电压。 设置只能在待机模式或旁路模式下操作。
		系统模式	对系统模式进行设置，可选择的模式：正常模式、变频模式。 系统模式的设置只能在待机模式下操作，否则点击保存后弹框提示“当前模式禁止设置！”。
		智能卡波特率	CSB 板上有三个智能卡插槽，可对这三个插槽的波特率进行设置。
		服务提醒	UPS 自安装使用之日起通过自动计时功能提供定期维护提醒报务，包括过保提醒，维护提醒
		装机时间	设置装机时间，格式：YYYY-MM-DD。
		复位密码	可进行复位控制密码、复位配置密码，解锁 XCP 烧录操作。复位后，控制密码和配置密码默认为禁止。XCP 烧录解锁 30 分钟后又重新锁定。
		导出记录	将保存的历史记录导出到 USB 设备，最多可保存一万条历史记录。
	其它信息	显示 BUS 电压与电池温度的显示。	
关于	用户信息	显示”设置“项中内容。	
	版本信息	显示模块版本。	
	服务信息	显示过保信息日期，维护提醒日期，装机日期。	

说明：以下菜单画面和设置仅供参考，如有变更恕不另行通知。

8.2 主页

主页界面有两部分内容：菜单栏和系统状态模拟图。
模拟图分为三部分：系统供电状态、UPS 模块状态、负载状态。



图 7-5

①菜单栏

单击菜单栏可进入相应界面对系统状态进行查看、控制、设置等。菜单栏由 主页、参数、控制、记录、设置、关于 6 项组成。

②系统供电状态

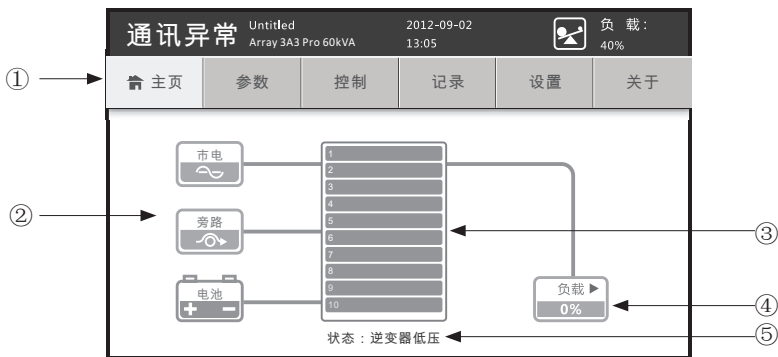
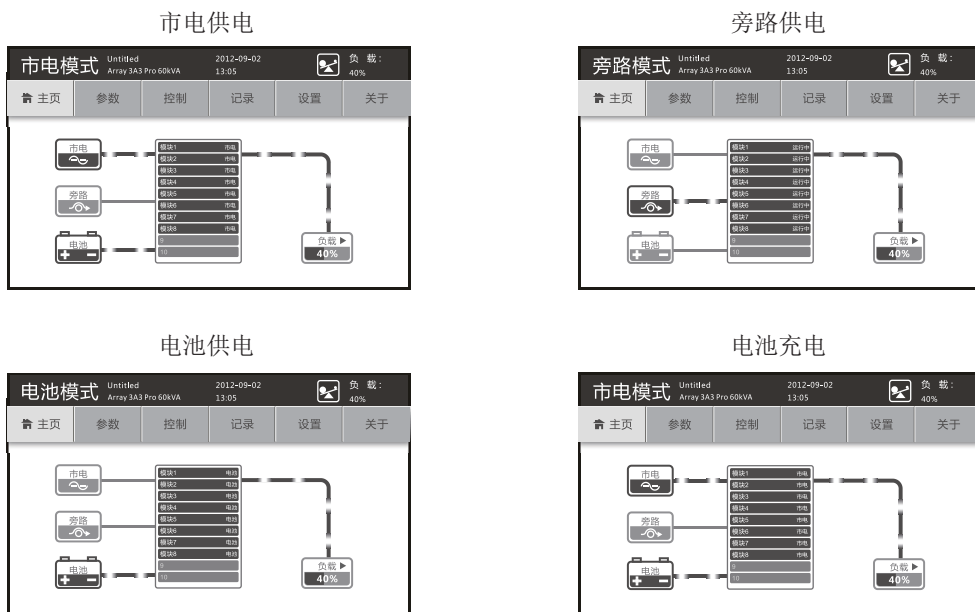

图标	说明
市电	<ol style="list-style-type: none"> 市电正常时，市电图标点亮；市电异常时，市电图标灰暗。 系统由市电供电时，显示市电线路的流动图。 点击此图标可跳转至系统参数界面查看输入信息。
旁路	<ol style="list-style-type: none"> 旁路正常时，旁路图标点亮；旁路异常时，旁路图标灰暗。 系统在旁路模式时，显示旁路线路的流动图；否则旁路供电电流图消失。 点击此图标可跳转至系统参数界面查看旁路信息。
电池	<ol style="list-style-type: none"> 带电池时，电池图标点亮；电池未接时，电池图标灰暗； 系统由电池供电时，显示电池线路的流动图，电流流向为电池→UPS。 系统给电池充电时，显示电池线路的流动图，电流流向为UPS→电池。 点击此图标可跳转至电池参数界面查看电池信息。

③ UPS 模块状态

可显示各个 UPS 模块的状态，最多显示 10 个模块的图标。

模块处于不同状态时，其图标的颜色将会变化，并配有文字说明。

模块图标颜色的含义如下：

颜色	含义	备注
灰色	未插入模块或模块状态未知	点击整个 UPS 任何位置可跳转至模块参数界面，以便查看每个模块的状态。
淡蓝	模块处于待机、关机等模式	
绿色	模块处于市电、变频、电池、电池自检等模式	
橙色	模块处于旁路模式	
红色	模块处于故障模式	

④负载状态

UPS 带载时其输出线路将以流动图显示，否则输出线路变灰。单击负载图标可跳转至系统输出参数界面查看具体负载信息，系统总的负载百分比以数字和刻度条的形式显示。

⑤系统告警

主页底部将实时显示系统的告警信息，当系统有多条告警时，告警信息将滚动显示。

8.3 参数

①点击主页菜单“参数”图标进入参数界面。



②点击“系统参数”，进入系统参数界面。若系统参数界面是从主页面点击“市电”或“旁路”图标进入，则退出时直接返回主页。

The screenshot shows the '系统参数' (System Parameters) interface. It features a table with two columns: '电压V' (Voltage V) and '频率Hz' (Frequency Hz). The table is divided into '输入' (Input) and '输出' (Output) sections. The '输入' section shows three rows (A, B, C) with values 218.5 V and 47.5 Hz. The '输出' section shows three rows (A, B, C) with values 220.2 V and 50.2 Hz. A '详细' (Details) button is visible next to the output section.

	电压V	频率Hz
输入	A 218.5	47.5
	B 218.5	47.5
	C 218.5	47.5
旁路	A 218.5	47.5
	B 218.5	47.5
	C 218.5	47.5
输出	A 220.2	50.2
	B 220.2	50.2
	C 220.2	50.2

③点击“模块参数”，进入模块参数界面。若模块参数界面从主页面点击 UPS 图标进入，则退出时直接返回图标。

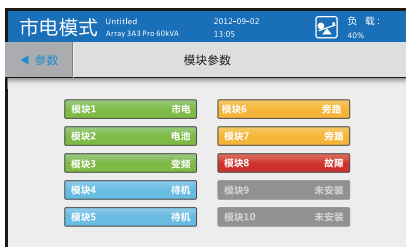

④点击“电池参数”，进入电池参数界面。若从主页面点击“电池”图标进入此界面，则退出时直接返回主页。

a. 电池电流禁止、后备时间禁止

The screenshot shows the '电池参数' (Battery Parameters) interface. It displays a table with columns for '状态' (Status), '电压V' (Voltage V), and '容量%' (Capacity %). The table has two rows: '正电池' (Positive Battery) and '负电池' (Negative Battery). Both rows show '电池未接' (Battery disconnected) status, 220.2 V, and 90% capacity.

	状态	电压V	容量%
正电池	电池未接	220.2	90%
负电池	电池未接	220.2	90%

b. 电池电流使能、后备时间禁止

The screenshot shows the '电池参数' (Battery Parameters) interface. It displays a table with columns for '状态' (Status), '电压V' (Voltage V), '电流A' (Current A), and '容量%' (Capacity %). The table has two rows: '正电池' (Positive Battery) and '负电池' (Negative Battery). Both rows show '电池未接' (Battery disconnected) status, 220.2 V, 45.0 A, and 90% capacity.

	状态	电压V	电流A	容量%
正电池	电池未接	220.2	45.0	90%
负电池	电池未接	220.2	45.0	90%

a. 电池电流禁止、后备时间使能

市电模式					
参数		电池参数			
状态	电压V	容量%	后备时间min		
正电池	电池未接	220.2	90%	35	
负电池	电池未接	220.2	90%	35	

b. 电池电流使能、后备时间使能

市电模式					
参数		电池参数			
状态	电压V	电流A	容量%	后备时间min	
正电池	电池未接	220.2	45.0	90%	35
负电池	电池未接	220.2	45.0	90%	35

8.4 控制

①点击主页菜单“控制”图标进入登录界面，进入系统控制界面时需要输入控制密码或用户密码或服务密码，控制密码或用户密码初始值为：1111、1234。

“控制密码”可用“用户密码”或“服务密码”替代。

“用户密码”可用“服务密码”替代。

②密码输入成功后进入“系统控制”界面。

“系统控制”界面有“开机、关机转旁路、关机、开启自检”按钮。

开机、关机转旁路、关机三个按钮点亮后的颜色分别为绿色、橙色、红色。详细操作请参考 7.2 与 7.3 章节。

③点击“开启自检”，弹出确认提示框。



④若系统不在市电模式或变频模式，则弹框提示“请在市电模式或变频模式下电池自检！”。请于状态栏确认UPS是否处于市电模式或变频模式，否则请进入控制界面开机后方可进行自检。



8.5 记录

①点击主页菜单“记录”图标进入记录界面。



②点击“清除记录”，输入服务密码后进入清除记录界面。



③点击“当前事件”，进入当前事件界面。详情见下表。



内容	说明
事件 ID	事件的 ID 号，显示范围 0~65535。
事件名称	此事件的描述。
事件类型	状态、命令、提示、告警。
来源	事件发生的模块。

④点击“系统记录”，输入服务密码后进入系统记录界面。详情见下表。



内容	说明
时间	事件发生的时间，格式：YYYY/MM/DD hh:mm:ss:xxx，xxx 为毫秒。
事件 ID	事件的 ID 号，显示范围 0~65535。
事件名称	此事件的描述。
事件类型	状态、命令、提示、告警。
来源	事件发生的模块。包括：CSB、UPM1~UPM10。
数据	系统记录的数据，范围 0~65535

8.6 设置

①点击主页菜单“设置”图标进入设置界面，配置项主要提供给客户使用，服务项主要提供给客服和维护人员。



②点击“配置”，输入密码成功后进入配置界面。



③点击“服务”，输入密码成功后进入服务界面。



8.6.1 配置

①进入“语言选择”界面，当前语言的按钮以蓝色显示，其余按钮以灰白色显示。



②进入“机器名称”界面，由用户对机器名称进行设置，仅限 14 个字符。



③进入“时间设置”界面，设置系统时间。



⑤进入“屏保时间”界面，设置屏保时间。
设置范围：10 ~ 60min。



⑦进入“LCD 背光”界面，设置背光灯亮度。
设置范围：1% ~ 100%。

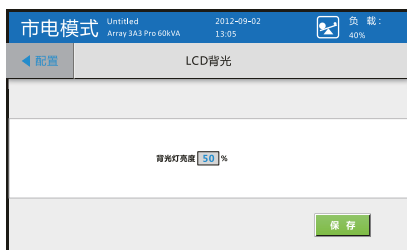

⑨进入“配置密码”界面，可设置配置密码为
使能或禁止状态与密码修改功能。



④进入“电池自检”界面，设置电池自检时
间，设置范围：0 ~ 9000s，默认自检时间为
10s。



⑥进入“灯光测试”界面，可进行灯光测试。



⑧进入“控制密码”界面，可设置控制密码为
使能或禁止状态与密码修改功能。



⑩进入“联系客服”界面，设置客服的联系电
话，最多可输入 13 个字符。



8.6.2 服务

①进入“电池设置”界面，对电池配置、充电、放电进行设置。

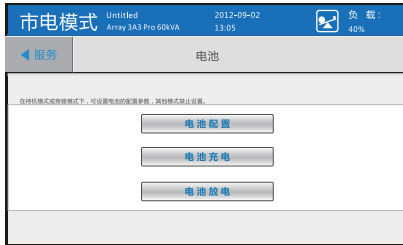

②进入“电池配置”界面，对电池进行设置。



③进入“输出设置”界面，对系统输出电压、频率进行设置。

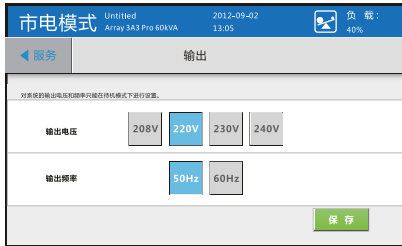

④进入“旁路设置”界面，设置上下限电压。



⑤进入“系统模式”界面，对系统模式进行设置。



⑥进入“智能卡波特率”界面，可对三个插槽的波特率进行设置。



⑦进入“服务提醒”界面，可设置过保提醒与维护提醒。



⑧进入“装机时间”界面，设置装机时间。



⑨进入“复位密码”界面，可对密码进行复位和解锁 XCP 烧录。



⑩进入“导出记录”界面，可导出历史记录到 USB。



⑪进入“其它信息”界面，可查看 BUS 电压等信息。

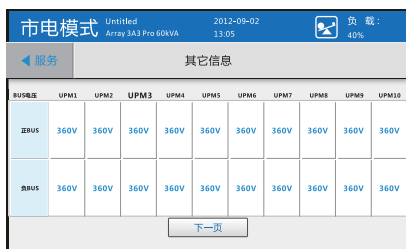

8.7 关于

①点击主页菜单“关于”图标进入关于界面。



②点击“用户信息”，进入用户信息界面。



③点击“版本信息”，进入版本信息界面。

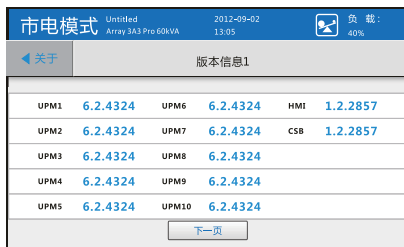

④点击“服务信息”，进入服务信息界面。



第九章 UPS 维护

9.1 维护需知

1. UPS 维护及电池维护应由培训合格的专业技术人员进行，用户不得自行进行维护。
2. 若长期不使用电池组时，常温下须每隔三个月对电池回充电一次，直至充饱，高温下须每隔两个月对电池回充电一次，直至充饱。
3. UPS 后部分为上下两部分，上部分装有维护旁路开关及输出开关，正常情况下不要操作这两个开关以免造成设备断电或更严重事故；下部分是带电铜条和模块输入开关，机柜的门是锁住的，请不要以任何方式将门打开，以免出现电击事故。

9.2 维护方式

UPS 如出现故障且故障原因不明时，请就近联系本公司的维护网点或经销商，也可直接拨打 400-889-3938 热线电话咨询，切不可盲目操作。

9.3 维护旁路流程

注意：用户只能在 UPS 出现故障，造成用电设备断电时才能执行此项操作。执行前请先仔细阅读操作流程，有任何疑问请先咨询本公司的维护网点或经销商，待完全清楚后方可操作。

1. 转维护旁路操作流程

- 1) 打开 UPS 机柜的“维护后门”（UPS 机柜后部上面的门）。
- 2) 向右拉开维护开关挡板（图 9-1）。



图 9-1

注意：理论上 UPS 应该自动转旁路工作，请查询 LCD 的提示，确认 UPS 已经转旁路工作，否则不要进行下一步操作。

- 3) 将维护开关打到 ON 位置（图 9-2）
- 4) 将 UPS 输出开关旋转到 OFF 位置（图 9-3）
- 5) 将 UPS 模块的输入开关和电池开关打到 OFF 位置

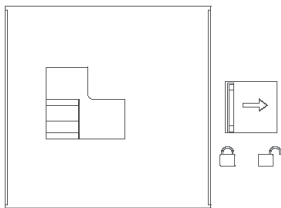

图 9-2



图 9-3

2. 从维护旁路恢复到 UPS 输出的操作流程

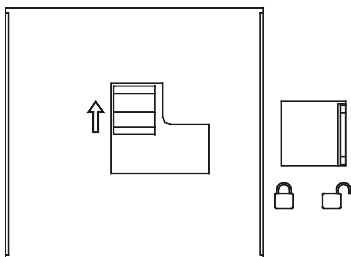
- 1) 将电池开关、UPS 模块输入开关打到 ON 位置。
- 2) 待 UPS 模块全部进旁路模式后，将 UPS 输出开关旋转到 ON 位置（图 9-4）。

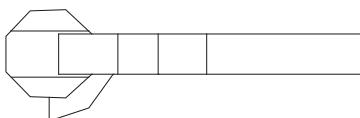
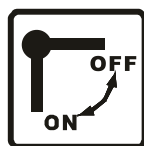
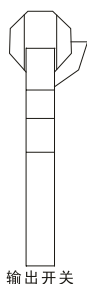

输出开关

图 9-4



图 9-5



图 9-6

- 3) 将维护旁路开关打到 OFF 位置（图 9-5）
- 4) 向左关闭维护开关挡板（图 9-6）
- 5) 在 LCD 显示、操作面板上执行开机

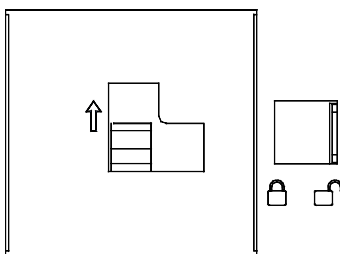
第十章 通讯界面

10.1 通讯接口介绍

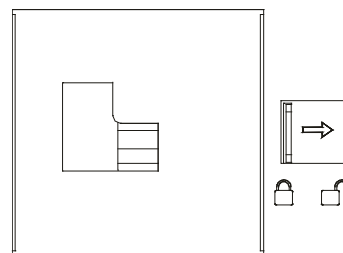
ARRAY 系列 UPS 具有丰富的通讯接口，其中包括智能插槽（Intelligent Slot），紧急开关（EPO）和温度侦测，通过这些通讯接口，用户可以方便地用计算机监控 UPS 的状态（通讯接口位置如图 10-1）。



图 10-1

10.2 紧急开关

紧急关机也称 EPO（Emergent Power Off），EPO 端子位于 UPS 单元后面板右上部，呈绿色端子，通过 EPO 端子可以完成本地或远程的关机动作，实现紧急情况下的 UPS 关机功能。

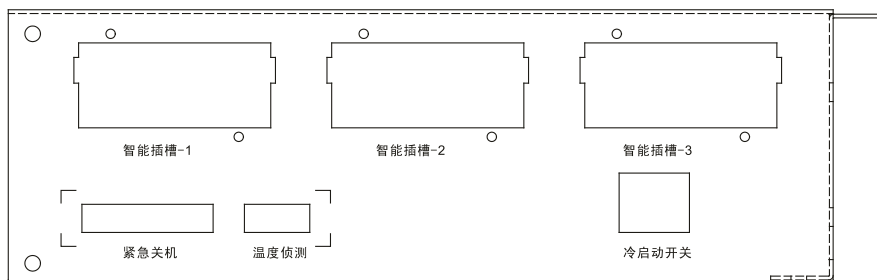

图 10-2

说明：

1-2 短接，3-4 同时短接：UPS 执行紧急关机；
其他情况下（包括悬空）：UPS 处于正常状态。

10.3 智能插槽

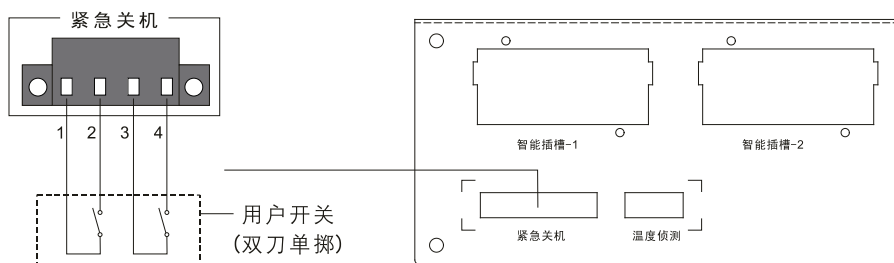
ARRAY 3A3 Pro 有三个智能卡插槽，可同时兼容三张智能卡，智能卡可提供丰富的通信接口，其中包括 RS232、USB 和干接点等方式实现 UPS 的远程监控和管理。



图 10-3

UPS 提供 3 个智能插槽，可选装如下卡：

USB+RS232 卡：提供标准的 USB 和 RS232 通讯接口，任选一种接口监控 UPS 的运行状态。

AS400 卡：利用 AS400 干节点界面，以接点讯号来反应 UPS 的运行状态，实现对电源的监控管理功能。

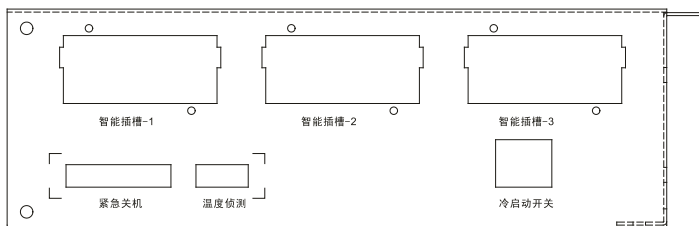
NMC 卡：通过 Internet 实现对 UPS 的远程监控和管理功能。

CMC 卡：通过 MODBUS 软件远程监控 UPS 的运行状态。

说明：

1. 安装智能卡的过程中不需要停止运行 UPS。
2. 安装智能卡之前先拆下智能卡插槽盖板，拆下的盖板保留以备将来用。
3. USB+RS232 卡提供了 USB 和 RS232 两种接口，供用户选择其中一种接口同 PC 连接。
4. 有关 WinPower 软件及 USB+RS232、AS400、NMC、CMC 卡的使用请参考其它相关资料，如果对上述通讯接口的使用有疑问，请拨打 400-889-3938 咨询。

10.4 温度侦测（选配）

电池对温度相对敏感，温度侦测端口一端连着的温度传感器可以及时侦测电池温度的变化，UPM 会根据温度自动调整充电电压，保证电池在高温时不过充，低温时不欠充，从而提高电池的使用寿命。按长度可分为 5m 和 2m 不同长短的温度传感器，客户可根据实际安装场景找当地代理商购买。



图 10-4

第十一章 常见问题处理

3A3 Pro UPS 在初次安装或者使用过程中失去正常功能时，这种情况可能是使用不当造成的，请先检查安装、配线、使用等方面是否存在不当，确认无误后，再与我公司客服中心联络，当您与维修人员联络时，请提供下列资料：

1. 机器序列号（机器后盖板上或在液晶显示板上查询）。
2. 问题发生时的 LCD 显示屏显示的信息及信号灯的状态。

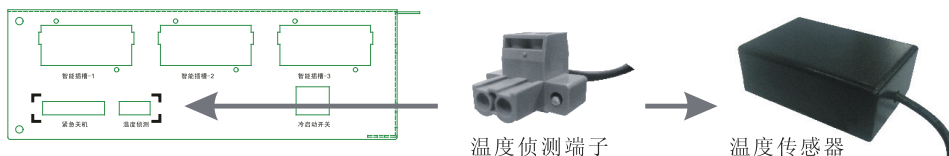
3A3 Pro UPS 在安装与操作方面有一定的约定条件，阅读使用手册的过程中请特别注意“注意”部分的内容，为了更好的配合用户的使用，下面列出了一些常见问题的处理方法，供参考。

11.1 LCD 显示常见问题

问题 1： 通讯界面无法正常工作。

可能原因： 通讯模块未插好。

解决方法： 将通讯模块拔出再重新插到底。

11.2 UPS 模块常见问题

问题 1： 无法检测到插入的模块。

可能原因： UPS 模块没有完全插到位。

解决方法： 将 UPS 模块抽出再重新插入。

问题 2： 新插入 UPS 模块无法开机。

可能原因： 新插入 UPS 模块的定位开关未处于锁定状态或输入开关未闭合。

解决方法： 锁定定位开关，闭合输入开关。

问题 3： UPS 不入市电。

可能原因： 输入相序不对，输入电压幅值或频率超出范围。

解决方法： 检查输入市电电压频率是否正常，相序若接反可将任何两相对调即可。

问题 4： 直流开机时，LCD 无法检测到 UPS 模块。

可能原因： UPS 模块电源建立后 30s 内若未收到开机指令将自行切断电源，可能是未及时开机引起。

解决方法： UPS 模块电源建立后，在 30s 内开机。

问题 5： 并机运行在旁路模式而无法转回市电模式。

可能原因： 维护口内维护旁路开关挡板未处于锁定状态。

解决方法： 将维护旁路开关挡板置于锁定状态。

问题 6: 并机运行中，突然一模块蓝灯闪烁，并且 **LCD** 显示该模块位置闪烁。

可能原因：该模块内部故障。

解决方法：按模块在线拆卸步骤抽出模块，插入新模块，按模块在线增加步骤开机。

11.3 电池及充电器常见问题

问题 1: 市电模式下没有充电电压和充电电流。

可能原因：开机时系统侦测到电池未接，从而关闭充电器。

解决方法：在 **LCD** 面板上选择电池自检操作，检测到电池后充电器自动打开。

问题 2: 有电池但自检失败。

可能原因：电池开关未闭合，或电池已损坏。

解决方法：检查电池开关，若电池损坏，请更换电池。

第十二章 产品规格

12.1 电气规格

12.1.1 输入规格：

接线：三相 + 零线 + 地线

电压：124-300VAC（相电压）；214-520VAC（线电压）

频率：40-70Hz

功率因数： ≥ 0.99

旁路电压范围：187-253VAC（相电压）；323-437VAC（线电压）

12.1.2 输出规格：

接 线：三相 + 零线 + 地线

电 压： $380 \times (1 \pm 1\%)$ VAC

功率因数：0.9

频 率：与输入市电同步，当市电频率超出范围时，输出频率为 $50 \times (1 \pm 0.5\%)$ Hz（市电模式）；
 $50 \times (1 \pm 0.5\%)$ Hz（电池模式）

过载时间： ≥ 10 分钟（ $110\% < \text{负载} \leq 130\%$ ）

UPS 效率：Up to 94 %

12.1.3 电池标称电压及充电电流

单边电池节数：16/17/18/19/20

正电池电压： $+192\text{VDC}/+204\text{VDC}/+216\text{VDC}/+224\text{VDC}/+240\text{VDC}$ ；

正电池充电电流： $3.5\text{A} \times \text{模块数}$

负电池电压： $-192\text{VDC}/-204\text{VDC}/-216\text{VDC}/-224\text{VDC}/-240\text{VDC}$ ；

负电池充电电流： $3.5\text{A} \times \text{模块数}$

12.2 噪声

$< 62\text{dB}$

12.3 工作环境

环境温度：0-40℃

环境湿度：20-90%

海拔高度： $\leq 1000\text{m}$

储藏温度： -25 - 55 ℃

12.4 尺寸及净重

品 名	尺寸 W×D×H (mm)	净重 (kg)
2.0 米 60kVA 下出线机柜	600×1050×2030	200
2.0 米 90kVA 上出线机柜	600×1050×2030	230
2.0 米 90kVA 下出线机柜	600×1050×2030	230
2.0 米 120kVA 上出线机柜	600×1050×2030	265
2.0 米 120kVA 下出线机柜	600×1050×2030	265
2.0 米 150kVA 下出线机柜	600×1050×2030	275
配电盘	483×194×131	9
UPS 模块	440×707×131	35

第十三章 维修保证

本公司承诺：自购机之日起，为您提供三年免费保修服务。

凭经销商有效证明保修；

凭机器序列号保修。

在保修期间造成运输费用，由用户承担。如机器发生故障，请与就近的公司服务网点及经销商联系。

作为我们的用户，您将享有如下服务：

三年保修（含从本公司购买的电池）；

24 小时客户服务热线：400-889-3938；

全国联保；

网上技术服务支持：

网站：www.eaton.com/powerquality

网站咨询 / 专家解答信箱：upsservice@eaton.com

发生以下情况，不在保修范围内：

人为故障，保修期外；

机器序列号更改、丢失的成品；

因不可抗拒及外来原因引起的损坏或损失；

未经授权私自拆机或修改；

违反机器操作 / 使用规定；

使电池深度放电或人为造成损坏。

附录一 灯号参照表

序号	工作状态	面板灯号显示				告警声
		正常	电池	旁路	故障	
1	市电模式 / 变频模式					
	无告警	●				
	有告警	●			★	四秒一鸣
2	电池模式					
	无告警	●	●			
	有告警	●	●		★	四秒一鸣
3	电池自检					
	无告警	●	●			
	有告警	●	●		★	四秒一鸣
4	旁路模式 / 维修旁路					
	无告警			●		
	有告警			●	★	四秒一鸣
5	Fault模式					
	有旁路输出			●	★	四秒一鸣
	无旁路输出				★	四秒一鸣

若有出现不包含以上的显示或警示状况，请与经销商或拨公司服务热线咨询

● _ 指示灯长亮

★ _ 指示灯闪烁

注：

1. 主界面滚动显示当前“提示”和“告警”事件，只有告警级别的事件故障灯会闪烁，蜂鸣器4秒一鸣。
2. 若有告警，当进入“记录”—“当前事件”页面时，故障灯长亮，蜂鸣器停响。

附录二 电池配置

最少电池组数：由于一定容量的电池都有其充电及放电的上限，为维护电池的寿命，请按下列表格提供的信息与用户的要求相结合决定电池组数。

电池组数配置表：（无色、打斜线部分表示禁止配置，深色表示认可配置组数）

1. 24Ah 电池组数配置表：

电池组 功率	24Ah*1	24Ah*2	24Ah*3	24Ah*4	24Ah*5	24Ah*6	24Ah*7	24Ah*8
15kVA								
30kVA								
45kVA								
60kVA								
75kVA								
90kVA								
105kVA								
120kVA								
135kVA								
150kVA								

2. 38Ah 电池组数配置表

电池组 功率	38Ah*1	38Ah*2	38Ah*3	38Ah*4	38Ah*5	38Ah*6	38Ah*7	38Ah*8
15kVA								
30kVA								
45kVA								
60kVA								
75kVA								
90kVA								
105kVA								
120kVA								
135kVA								
150kVA								

3. 65Ah 电池组数配置表:

电池组 功率	65Ah*1	65Ah*2	65Ah*3	65Ah*4	65Ah*5	65Ah*6	65Ah*7	65Ah*8
15kVA								
30kVA								
45kVA								
60kVA								
75kVA								
90kVA								
105kVA								
120kVA								
135kVA								
150kVA								

4. 75Ah 电池组数配置表:

电池组 功率	75Ah*1	75Ah*2	75Ah*3	75Ah*4	75Ah*5	75Ah*6	75Ah*7	75Ah*8
15kVA								
30kVA								
45kVA								
60kVA								
75kVA								
90kVA								
105kVA								
120kVA								
135kVA								
150kVA								

5. 100Ah 电池组数配置表：

电池组 功率	100Ah*1	100Ah*2	100Ah*3	100Ah*4	100Ah*5	100Ah*6	100Ah*7	100Ah*8
15kVA								
30kVA								
45kVA								
60kVA								
75kVA								
90kVA								
105kVA								
120kVA								
135kVA								
150kVA								

6. 120Ah 电池组数配置表：

电池组 功率	120Ah*1	120Ah*2	120Ah*3	120Ah*4	120Ah*5	120Ah*6	120Ah*7	120Ah*8
15kVA								
30kVA								
45kVA								
60kVA								
75kVA								
90kVA								
105kVA								
120kVA								
135kVA								
150kVA								

Thanks for choosing our products!

All warnings and operation instructions in the manual and on the machine should be strictly followed and this user manual should be kept properly for future reference. Do not attempt to operate the UPS until reading through all safety information and operating instructions of this manual carefully.

Solemn Statement

Supervision Code Statement

To ensure consumer rights and safe electricity application, the following items should be heeded:

1. Labeled on each ARRAY 3A3 Pro UPS is an “electronic supervision code” (“electronic supervision code” is a code of product identification advocated by SIQSAQ in order to strike at fake commodities).
2. Consumer may identify the electronic monitoring code through the following methods and complete complaints or prosecution via “Product Identification Authentication Tracking System” website.

Inquiry method:

Website inquiry: access the website: www.95001111.com (Product Identification, Authentication and Tracking System) and input the supervision code;

Tel inquiry: Call 95001111 to check (you may call 010-95001111 and follow the instructions to enquire the identification);

Message inquiry: send text message to 106695001111 (available to both China Mobile and Unicom);

Any questions, you may call the telephone number at 95001111 or log on to www.95001111.com. for further details or lodge your complaints.

Copyright Statement

The company is dedicated to a continued effort of technological innovation and provision of improved products and services to satisfy customers' needs. Product design and technical specifications are subject to upgrading without notice. Actual product may differ from photo.

Please access www.eaton.com/powerquality to download the latest version of product instructions.

All Rights Reserved © 2013 Eaton Power Quality(shanghai) Co., Ltd

Safety Instructions

Operation Safety

1. Prior to the application, please read “Safety Instructions” carefully to ensure correct and safe application. Please keep the user manual properly.
2. During operation, attention should be paid to all warning symbols and operations should be followed strictly as required.
3. Equipment is not supposed to be used in environment that directly exposed to the sunlight or raindrops or in humid environment.
4. The equipment should not be installed close to area of thermal sources or any area where there is presence of devices such as electric heaters and furnaces.
5. Make sure the safety space should be left for proper ventilation and product maintenance when placing UPS. Refer to the instructions during installation.
6. Dry and non-conductive items should be used for cleaning.
7. In case of a fire hazard, dry powder extinguisher should be used properly. Using liquid fire extinguisher may result in electric shock hazard.
8. Storey bearing capacity of machine and batteries should be taken into consideration prior to installation.
9. Pulled out all UPS modules from the cabinet prior When transporting by casters.
When the UPS modules within the cabinet, the load of cabinet should be carried by adjustable feet(not by casters).

Electric Safety

1. Before electricity is switched on, make sure earthing is properly done and wire and battery polarity are correctly connected.
2. When UPS relocation or wire reconnection is necessary, AC and battery should be switched off and UPS should be completely turned off, otherwise there might be a danger of electric shock because output terminal might be still electrified.
3. Please use the company specified appendix devices and accessories.

Battery Safety

1. Battery service lifetime will be shortened as ambient temperature rises. Replace batteries periodically to guarantee normal UPS performance and sufficient back-up time.
2. Only personnel with proper expertise can carry out the maintenance of accumulator batteries.
3. Replacement of accumulator batteries requires a match of same type and model with equal quantity.
4. As accumulator batteries may contain potential electric shock and short-circuit current danger, to avoid accidents that might be thus resulted, the following warnings should be observed during battery replacement:
 - A. Do not wear watches, rings or similar metallic items;
 - B. Use insulated tools;
 - C. Put on rubber shoes and gloves;
 - D. Do not place metallic tools or similar metallic parts on the batteries;
 - E. Switch off load connected to the batteries before dismantling battery connection terminals.
5. Do not expose accumulator battery to fire in order to avoid possible explosion that might endanger physical safety.
6. Non-professionals are not allowed to open or destroy accumulator batteries for electrolytes in batteries contain strong acid and other dangerous substances which will cause damages to both human skins and eyes. Should electrolytes come into any contact with human body unintentionally, rinse with clean water and seek medical advice.
7. Do not cause battery positive and negative polarity short circuit otherwise electric shock or inflammation may occur.

Maintenance







1. Working environment and storage means can affect the service term and reliability of this product to some extent. Therefore, the product is not suitable for performance in the following environment:
 - A. Locations where temperature exceeds the maximum or goes below the minimum temperature as required by technical specifications or humidity is improper (temperature range: 0-40 °C ; relative humidity range: 20-90%).
 - B. Locations where vibration and collision are constant;
 - C. Locations where metallic dusts, corrosive substances as well as salts and inflammable gases are present.
2. For long-term inaction, UPS (without batteries) should be kept in dry environment with temperature ranging from -25-+55 °C . Before start-up, ambient temperature should be brought back to 0 or above for a certain period of time (above 2 hours).

Contents

Chapter 1 Brief introduction.....	1
Chapter 2 Unpacking.....	3
Chapter 3 Exterior appearance.....	5
Chapter 4 Installation instructions.....	8
Chapter 5 Electrical installation.....	11
Chapter 6 Adding/Reducing/Replacing modules online.....	17
Chapter 7 Operation.....	19
Chapter 8 Menu Commands.....	23
Chapter 9 Maintenance.....	35
Chapter 10 Communication interface.....	37
Chapter 11 Troubleshooting.....	39
Chapter 12 Product specifications.....	41
Chapter 13 Warranty.....	43
Appendix 1 The reference table of LED indicators.....	44
Appendix 2 Battery configuration.....	45

Chapter 1 Brief Introduction

1.1 Frequently used symbols

Symbols and Indications	
Symbol	Description
	Attention
	Dangerous high voltage
	Alternating current(AC)
	Direct current(DC)
	Grounding Protection
	Recycle
	Do not dispose with sundries

1.2 Application range

This manual is only applicable to the ARRAY 3A3 Pro UPS.

1.3 Product overview

3A3 Pro UPS belongs to the ARRAY UPS series. It is high-efficiency and high-performance, double conversion and pure-online UPS. Like other products of the ARRAY UPS series, the 3A3 Pro UPS adopts the design of drawer-style and high-intelligence modules. Every UPS module is a three-phase input and three-phase output UPS complete in function. The user can choose the most desirable UPS system by adding or reducing the UPS modules according to different needs and so to achieve the optimal price-performance ratio.

3A3 Pro UPS consists of the cabinet, UPS modules, PDU(optional),Surge arrester(optional) and Filter(optional). The cabinet is a height of 19 inches (2-meter). If the output power permits, the whole unit can run normally with one to ten modules installed and the modules can be added, reduced or replaced on-line easily without affecting the normal operation of other parts under all kinds of operating conditions. The capacity of one module is 15kVA and the total capacity of the whole unit is 150kVA when all ten modules are installed. The number of the UPS modules, the PDUs are not elective at will due to the limitation of the UPS cabinet space. Adding one of them (or the quantity) may mean reducing the another (or the quantity). Please refer to the relevant documents for detailed information.

With powerful communication modules, 3A3 Pro UPS is able to collect information of each module and carry out integrated monitoring of the module through the internal network of the unit, and all the information are displayed on a large LCD screen, which makes the UPS operation simple and easy.

3A3 Pro UPS is designed to prevent almost all of the power problems,such as power surges, high-voltage spikes, switching transients, power sags, electrical line noise, frequency variations, harmonics ,brownouts and blackouts. Therefore, the series products can be applied in a diversified fields such as computer equipments, communication systems and automatic equipments etc.

1.4 Product criterion

The 3A3 Pro UPS product complies with the following EMC standards:

EMC:	EMI	EMS	
IEC 62040-2:2005 C3 GB 7260.2 (I>25A)		IEC: 61000-4-2 (ESD)	GB/T17626.2
		61000-4-3 (RS)	GB/T17626.3
		61000-4-4 (EFT)	GB/T17626.4
		61000-4-5 (SURGE)	GB/T17626.5

Warning: The product is proposed to be applied in C3 environment; installation restrictions or additional measures are needed to prevent disturbances if applied in C2 environment.

Safety: GB 4943.1-2011 Information technology equipment-Safety Part: General requirements.
YD/T 1095-2008 Uninterruptible Power Systems for Communications.

1.5 Hotline service

If you have any questions, please dial 400-889-3938 for toll-free hot line service, our professional technical personnel will provide 24-hour hotline service for you.

Chapter 2 Unpacking

2.1 Unpacking inspection

Note: check whether the UPS is damaged during the process of transportation or not. Should any damage be observed or parts be found missing, do not start the machine. Contact the forwarder and distributor immediately. Check the accessories supplied with the UPS and there should be:

- 1) one user manual;
- 2) Accessory includes screws ,cable tie and two keys.

- 1.Disassemble the top cover: cut off the packing tape by scissors and remove the top cover(Fig.2-1);
- 2.Disassemble the Side panels: adjust the plug tongue by Pliers and remove the Side panels(Fig.2-2);
- 3.Remove the foam and plastic bag around the unit(Fig.2-3);
- 4.Disassemble the screws which used to fix the mounting brackets by wrench, and adjust the height of adjustable feet(Fig.2-4);
- 5.Atleast 2 people is required to push the cabinet to the ground carefully by slope board(Fig.2-5);

Note: Make sure that the heights of the door and some other obstacles are appropriate.

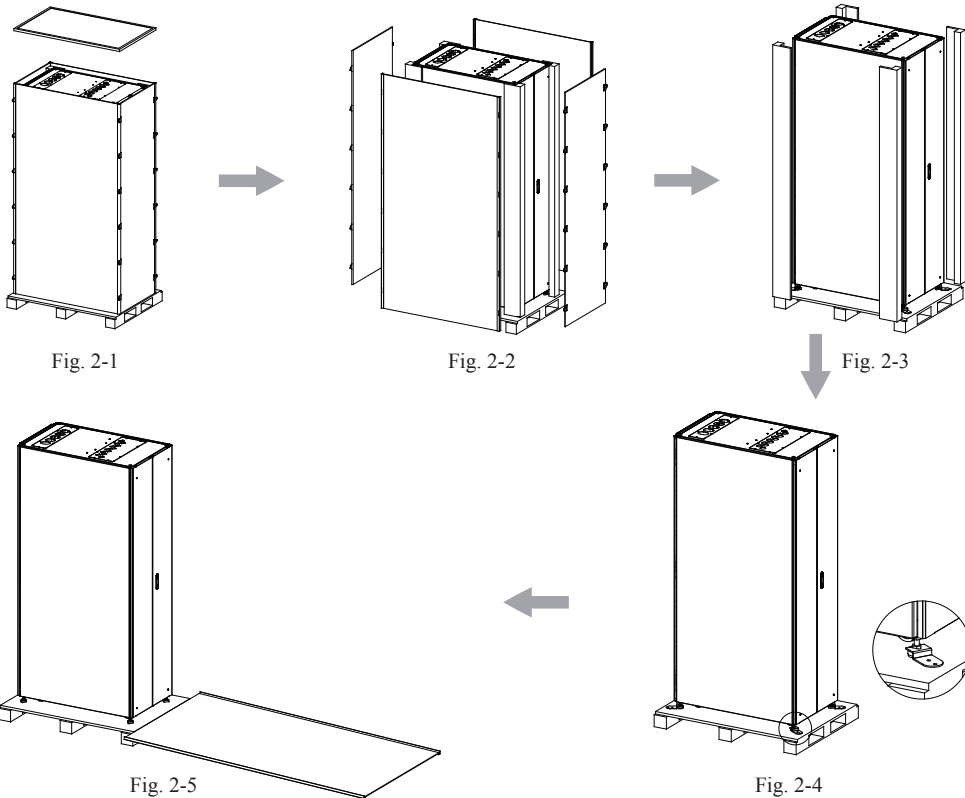

2.2 Instruction for removing the module packaging

1. Cut off the packing strap and open the carton (see Fig. 2-6);
2. Lift the foam on the UPS module upward to remove them (see Fig.2-7);
3. Take out the UPS module (see Fig. 2-8).

Note: the UPS is heavy. It requires two people for transportation due to its weight.

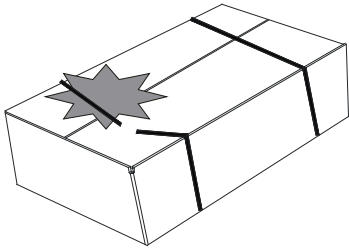

Fig. 2-6

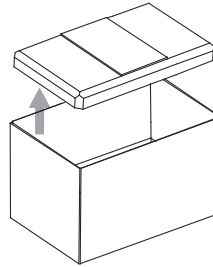

Fig. 2-7

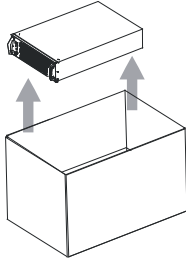

Fig. 2-8

Chapter 3 Exterior Appearance

3.1 Exterior figure of the UPS

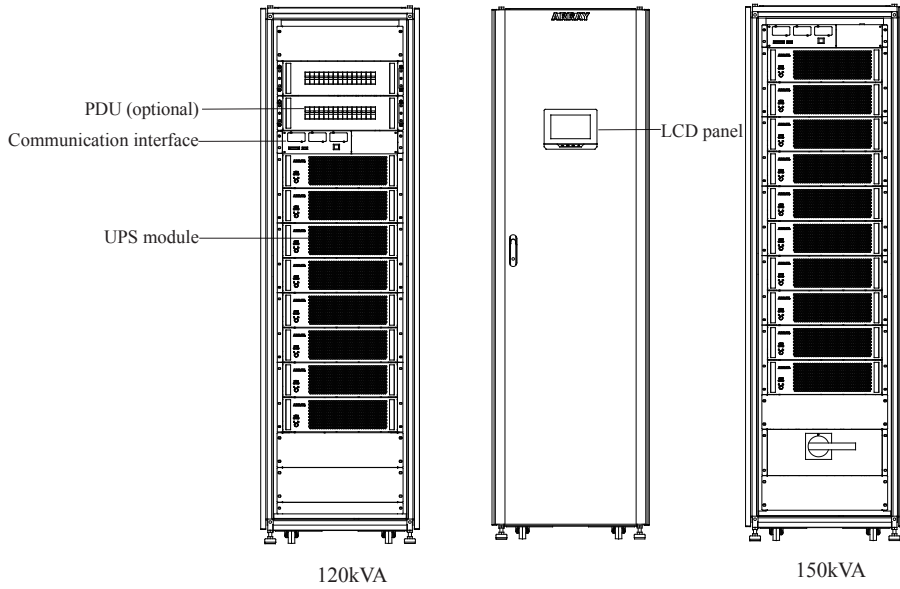

Fig. 3-1 Front view

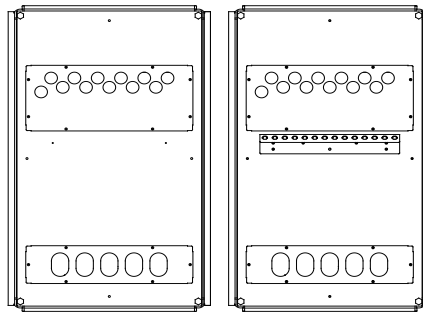

Fig. 3-2 Top view of cabinet with upper wire-outlet holes (the right figure containing of cable clamp)

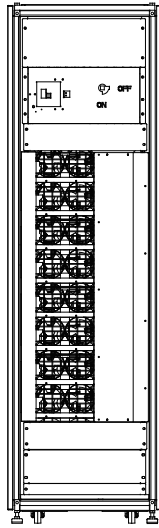

Fig. 3-3 120kVA rear view of cabinet with upper wire-outlet holes

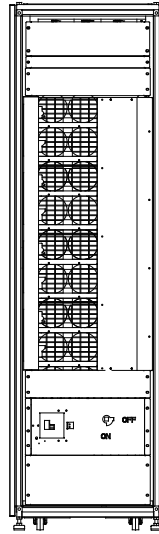

Fig. 3-4 120kVA rear view of cabinet with lower wire-outlet holes

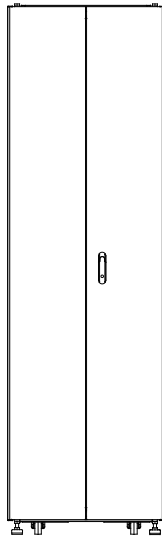

Fig. 3-5 150kVA rear view

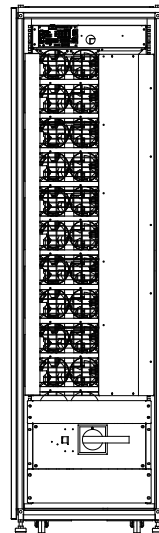

Fig. 3-6 150kVA rear view of cabinet with lower wire-outlet holes

3.2 Exterior figure of the module

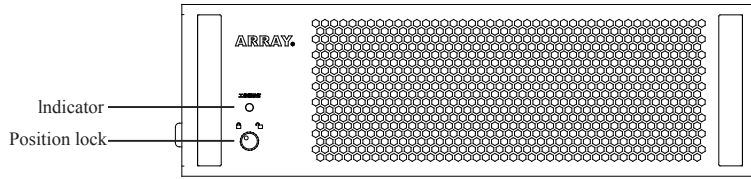

Fig. 3-7 Front view

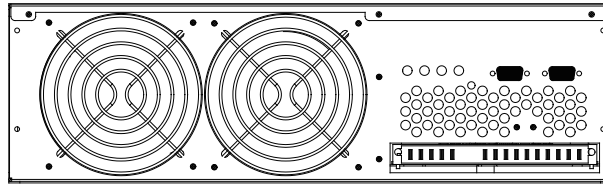

Fig. 3-8 Rear view

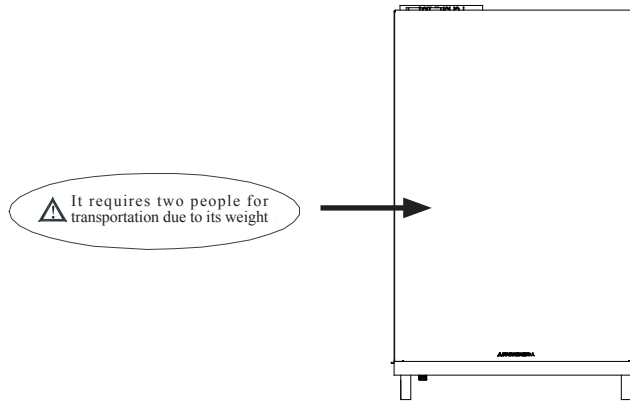

Fig. 3-9 Top view

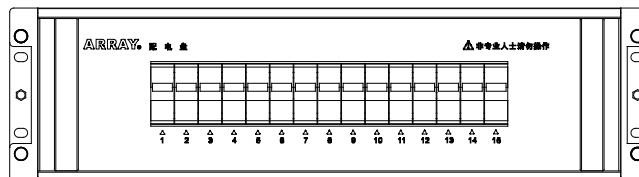

Fig.3-10 PDU front view

Chapter 4 Installation Instructions

4.1 Installation notice

1. Install the UPS in a clean and stable environment that is free of vibration, dust, high humidity, flammable gas, flammable liquid or caustic substance.
2. The ambient temperature for the normal running UPS is required to be at 0°C - 40°C . If the UPS is operating in a more than 40°C environment, the maximum load capacity is required to be in accordance with the rating by 12% capacity decrease for every 5°C temperature rise. The maximum ambient temperature is required to be no more than 50°C .
3. It is recommended that the battery pack be used at the temperature of 15°C -25°C .
4. Altitude for normal UPS function should not exceed 1000m. Should UPS be intended for application above 1000m, progressive decrease of rated output should be applied as listed in the following:

(Nominal power capacity of the UPS = the maximum power capacity in a high altitude area * Derating power)

Altitude (M)	1000	1500	2000	2500	3000	3500	4000	4500	5000
Derating Power	100%	95%	91%	86%	82%	78%	74%	70%	67%

5. 3A3 Pro UPS utilizes fans for forced cooling, so considering ventilation for installation site is a must. Do not block the panels since there are ventilation grids in both the front and rear panels of the UPS.
6. 3A3 Pro UPS adopts the positive-negative battery supply configuration. One battery pack consists of 32-40 batteries in series, which is divided into two parts by a neutral wire connecting to the middle of the pack. Therefore there are altogether three wires connected with the UPS terminal blocks including the positive and negative wires of the battery pack. The batteries between the positive terminal of the battery pack and the neutral wire are positive battery; while the batteries between the negative terminal and the neutral wire are negative battery (refer to the connection diagram for detailed information). You can choose the battery capacity and battery pack quantity according to your need. UPS capacity is varied with different battery configuration. The de-rating factor is shown in below table:

Battery to Qty	40	38	36	34	32
Derating Power	100%	95%	90%	85%	80%

7. Wire Connection: the 3A3 Pro UPS is a three-phase input and three-phase output UPS and the input wire must be connected to the three-phase live wire and neutral wire. The output can be connected in different ways (Δ , Y or some other ways) according to the loads. Refer to the connection diagram for detailed information.
8. Wiring standard: the 3A3 Pro UPS adopts modular design and you may choose the quantity of the modules according to the load. It is recommended that the wiring be connected according to the maximum load for the safe use of the unit and the easy load expansion. The user can also perform the wiring according to the capacity of the modules. Refer to the table of wiring configuration in this manual.

4.2 Installation space

There must be at least 1000mm ($D1 \geq 1000\text{mm}$) of space in front of the front panel of the UPS and at least 800mm ($D3 \geq 800\text{mm}$) of space reserved behind the rear panel of the UPS for maintenance and air-cooling.

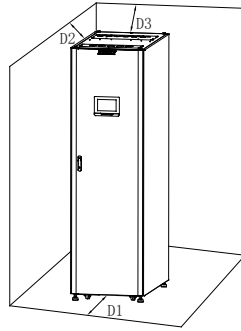

Fig. 4-1

4.3 Installation process

1. Disassemble the screws which used to fix the mounting brackets by socket or wrench, and adjust the height of adjustable feet (Fig. 2-4);
2. Push the cabinet to the predetermined location and adjust the height of adjustable feet by wrench to set the casters in vacant position.
3. Fix the adjustable feet with the mounting brackets (by M8 anchor bolts, Fig. 4-2)

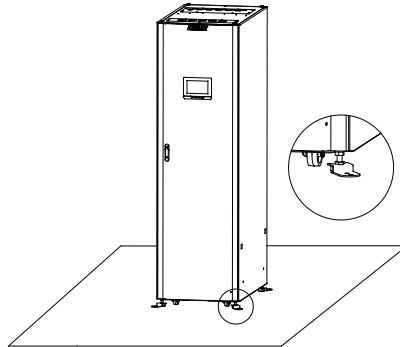





Fig. 4-2

4. Remove the packaging of the UPS module and check the position lock located on the front panel of the module. In normal condition, the white dot on the position lock should be at the position of “” (Fig. 4-2); if the white dot is at the position of “”, please turn it to the “” position.

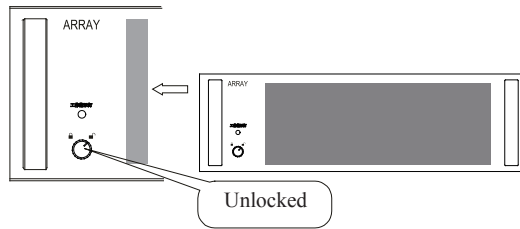



Fig. 4-3

5. Slide the UPS module into a bay of the frame until it is in the cabinet completely.
Note: the module is heavy. It requires two people for installation due to its weight.
 6. Set the position lock on the front panel of the module to the “” position (Fig.4-4);
 7. Repeat the above 4-6 steps to install all of the UPS modules into the cabinet in sequence. (Fig.4-5);
 8. Install the PDU module (optional): Remove the plastic blind plate and adjust the position of caged nuts, fix the PDU to predetermined position with the M6 hex screws;
 9. PDU wiring (optional): Connect the cabal on PDU to the corresponding output copper bus bars of UPS.
- Note: The height of PDU is 3U,the distance between the 2 mounting hole is 2U.

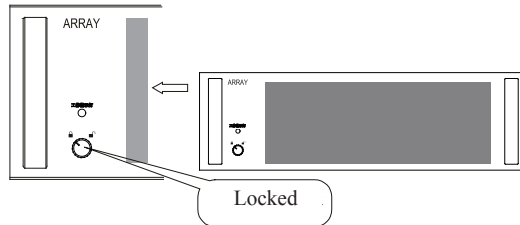

Fig. 4-4

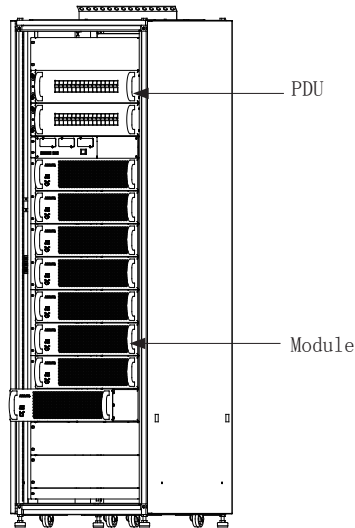

Fig. 4-5

Chapter 5 Electrical Installation

The electrical installation of the 3A3 Pro UPS must be performed according to the electrical code and the 3A3 Pro UPS installation specifications by a qualified engineer that has passed the training. Any other personnel with no qualification are forbidden to perform the installation. Only basic installation instructions are included in this manual and please refer to the installation specifications for detailed information.

5.1 Requirements of wiring cables

The 3A3 Pro UPS provides four options on its cabinet capacity (maximum UPS modules that can be contained in the cabinet): 60kVA (maximum four UPS modules), 90kVA (maximum six UPS modules), 120kVA (maximum eight UPS modules) and 150kVA (maximum ten UPS modules). And overload and line voltage should also be taken into consideration for wire diameter selection on the basis of the cabinet capacity options. It is generally recommended that the user choose the wire diameter according to the maximum capacity of the UPS cabinet, which can ensure that there is no need to change the wire diameter when expanding the capacity of the UPS.

If the quantity of the UPS modules installed is less than the capacity of the UPS cabinet, the user can also choose the wire diameter according to the actual needs. The wire diameter may vary with the quantity of the UPS modules installed. Please refer to the table below for module quantity and corresponding wire diameter.

Module	Cable Cross Section									
	UPS Input				UPS Output				Battery Cable	
	L		N		L		N		UL	GB
UL	GB	UL	GB	UL	GB	UL	GB			
1	12AWG	6mm ²	6AWG	16mm ²	12AWG	6mm ²	6AWG	16mm ²	12AWG	6mm ²
2	6AWG	16mm ²	6AWG*2	16mm ² *2	6AWG	16mm ²	6AWG*2	16mm ² *2	6AWG	16mm ²
3	4AWG	25mm ²	4AWG*2	25mm ² *2	4AWG	25mm ²	4AWG*2	25mm ² *2	4AWG	25mm ²
4	6AWG*2	16mm ² *2	2AWG*2	35mm ² *2	6AWG*2	16mm ² *2	2AWG*2	35mm ² *2	6AWG*2	16mm ² *2
5	4AWG*2	25mm ² *2	4AWG*3	25mm ² *3	4AWG*2	25mm ² *2	4AWG*3	25mm ² *3	4AWG*2	25mm ² *2
6	4AWG*2	25mm ² *2	2AWG*3	35mm ² *3	4AWG*2	25mm ² *2	2AWG*3	35mm ² *3	4AWG*2	25mm ² *2
7	4AWG*2	25mm ² *2	2AWG*3	35mm ² *3	4AWG*2	25mm ² *2	2AWG*3	35mm ² *3	4AWG*2	25mm ² *2
8	2AWG*2	35mm ² *2	2AWG*3	35mm ² *3	2AWG*3	35mm ² *3	2AWG*3	35mm ² *3	2AWG*3	35mm ² *3
9	2AWG*3	35mm ² *3	4/0AWG*2	95mm ² *2	2AWG*3	35mm ² *3	4/0AWG*2	95mm ² *2	2AWG*3	35mm ² *3
10	1/0AWG*2	50mm ² *3	4/0AWG*2	95mm ² *2	1/0AWG*2	50mm ² *2	4/0AWG*2	95mm ² *2	1/0AWG*2	50mm ² *2

Note:

1. The conductor cross sections above apply for theoretical maximum currents in consideration of protective devices.
2. *n represents the number of the wire, which indicates that n same AWG wires are needed. For example, “2AWG*3” indicates that three 2 AWG wires are needed.
3. The diameter of the earth wire needs to be the same as the N wire.

5.2 Requirements of protective devices

The 3A3 Pro UPS supplies no breakers or protective components with its cabinet for input (including battery input). For output, only breakers are connected in the cabinet and no protective components are supplied. When installing the 3A3 Pro UPS, the user needs to connect the external breakers and protective components in the input and output terminals. It is recommended to select the NFB instead of the traditional combination kit including breaker and fuse.

The voltage and current should be taken into consideration when selecting NFB. And it is recommended to select it according to the real capacity of the UPS (the modules installed) to ensure effective protection. Please refer to the table below for UPS module and corresponding NFB requirements.

UPS Module	UPS Input NFB	UPS Output NFB	Battery NFB
	Voltage/Current	Voltage/Current	Voltage/Current
1	3φ 40A/ 250VAC	3φ 40A/ 250VAC	3φ 40A/ 500VDC
2	3φ 80A/ 250VAC	3φ 80A/ 250VAC	3φ 80A/ 500VDC
3	3φ 120A/ 250VAC	3φ 120A/ 250VAC	3φ 120A/ 500VDC
4	3φ 160A/ 250VAC	3φ 160A/ 250VAC	3φ 160A/ 500VDC
5	3φ 200A/ 250VAC	3φ 200A/ 250VAC	3φ 200A/ 500VDC
6	3φ 240A/ 250VAC	3φ 240A/ 250VAC	3φ 240A/ 500VDC
7	3φ 280A/ 250VAC	3φ 280A/ 250VAC	3φ 280A/ 500VDC
8	3φ 320A/ 250VAC	3φ 320A/ 250VAC	3φ 320A/ 500VDC
9	3φ 360A/ 250VAC	3φ 360A/ 250VAC	3φ 360A/ 500VDC
10	3φ 400A/ 250VAC	3φ 400A/ 250VAC	3φ 400A/ 500VDC

Note: it is recommended to choose three-pole NFBs (linked breaker) for the input and output of the UPS and a three-pole NFB (linked breaker) for the battery. Refer to the Section 5.3 and Section 5.4 in this manual for detailed information.

5.3 The wiring diagram

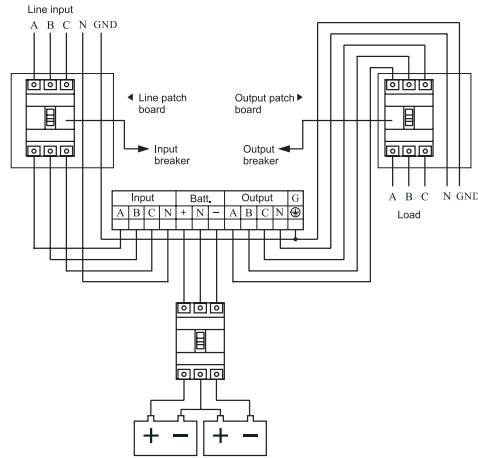

Fig. 5-1 The wiring diagram

Remark:

1. The input N wire of the UPS must be connected correctly.
2. One battery pack of the 3A3 Pro UPS consists of 32-40 batteries in series, 40PCS configuration is illustrated as an example in Fig. 5-2. which is divided into two parts by a neutral wire connecting to the middle of the pack (where the No. 20 and No. 21 batteries are connected). Therefore there are altogether three wires connected with the UPS terminal blocks including the positive and negative wires of the battery pack. The battery cables should connect to a DC breaker firstly and then it can be connected to the terminal block of the UPS. Please refer to the following wire connection diagram for detailed information.

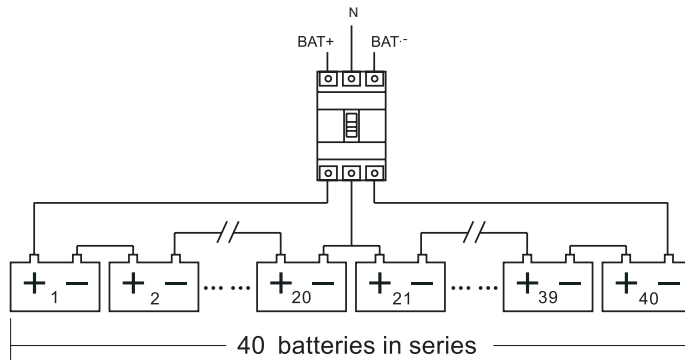

Fig. 5-2 Sketch map of Battery connected

Note: the three wires of the battery pack should be connected to the UPS correctly according to the marks, otherwise, it may cause hazards of battery short circuit. So make sure to double-check them before connection. It is required to use DC breakers complying with the safety requirements due to a multiple quantity of batteries in series.

5.4 Installation instructions

1. Wiring Location

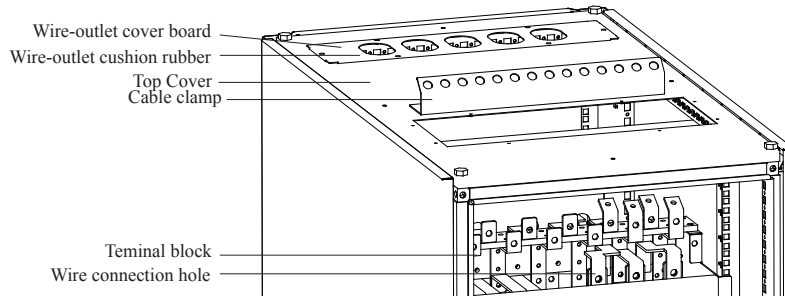

Fig. 5-3 Wiring location of cabinet with upper wire-outlet holes
(without the wire-outlet cover board besides the cable clamp)

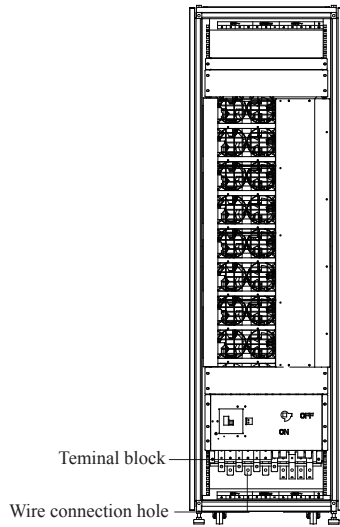

Fig. 5-4 Wiring location cabinet with lower wire-outlet holes

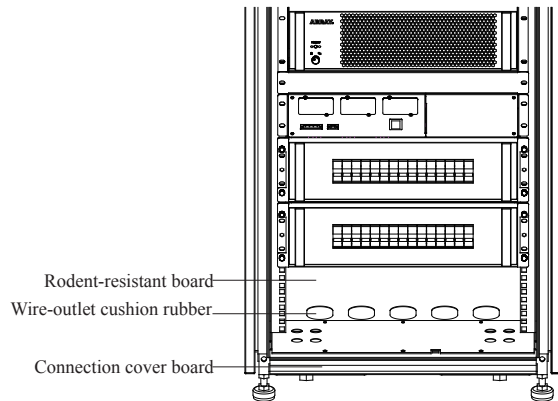

Fig. 5-5 Wiring location of reserved bottom power distribution panel

2. Electrical Installation Illustration

Wire connection cabinet with upper wire outlet holes

- 1) Remove the front terminal block cover (see Fig. 5-6).
- 2) Connect the UPS input, output and battery wires to the corresponding copper bars frontally through the wire cushion rubbers on the top cover according to the marks (the copper bar marks are shown as Fig. 5-7).
- 3) Reinstall the terminal block cover and secure it with screws.
- 4) Fix the wires to the cable clamp with cable ties.

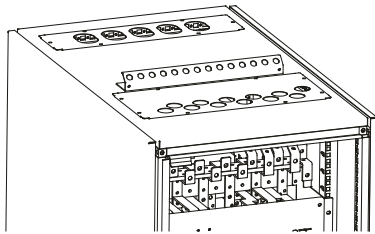

Fig. 5-6

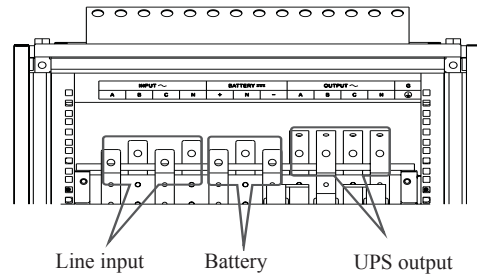

Fig. 5-7

Wire connection cabinet with lower wire outlet holes

- 1) Remove the front terminal block cover and bottom connection cover board (see Fig. 5-8).
- 2) Connect the UPS input, output and battery wires to the corresponding copper bars frontally through the wire cushion rubbers on the rodent-resistant board according to the marks (the copper bar marks are shown as Fig. 5-9).
- 3) Reinstall the front terminal block cover and bottom connection cover board and secure them with screws.

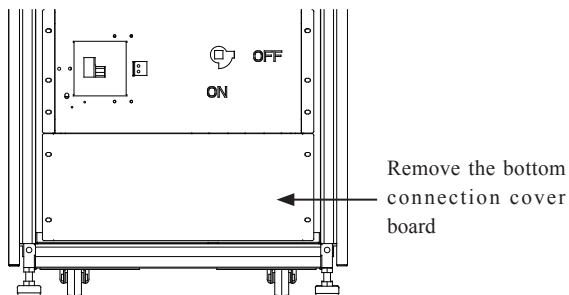

Fig. 5-8

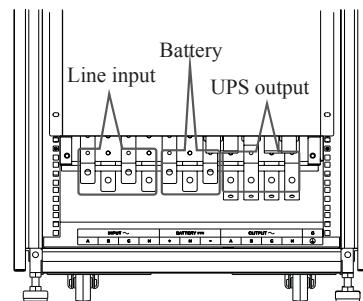

Fig. 5-9

Note:

Wire connection of 150kVA cabinet with lower wire outlet holes

- 1) Remove the rear terminal block cover and bottom connection cover board.
- 2) Connect the line input and battery wires to the corresponding copper bars through the wire cushion rubbers on the rodent-resistant board according to the marks (the copper bar marks are shown as Fig. 5-10).
- 3) Remove the front terminal block cover, connect the UPS output wires to the corresponding copper bars according to the marks (the copper bar marks are shown as Fig. 5-11). Prior to the wire connection, make sure earth connection has been done.
- 4) Reinstall the terminal block covers and bottom connection cover board and secure them with screws.

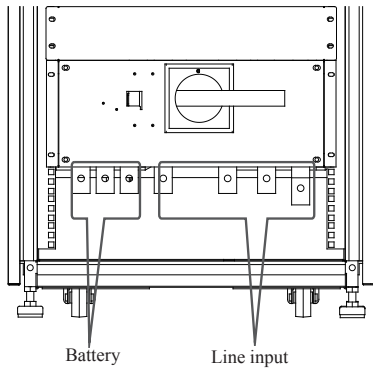

Fig. 5-10

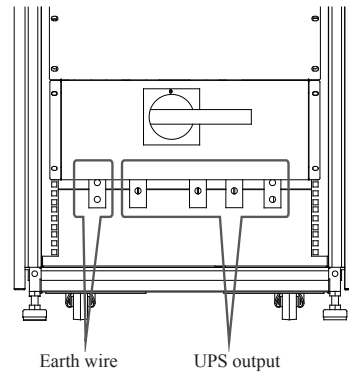

Fig. 5-11

Chapter 6 Adding/Reducing/Replacing Modules Online

N+X is the most reliable power supply configuration at present. N represents the minimum number of modules of the 3A3 Pro UPS that the total load needs; X represents the number of the redundant modules of the 3A3 Pro UPS, i.e. the number of the fault modules that the system can handle simultaneously. The bigger X is, the higher the system reliability is. The 3A3 Pro UPS can be installed up to 10 modules in its cabinet and the N+X parallel redundancy system can be configured as 1+9 or 9+1 etc multiple different modes. The 3A3 Pro UPS modules can be added, reduced and changed online and the quantity of the N and X of the N+X parallel redundancy system can be changed according to requirement at any time. When the modules fail, if only the quantity of the fault modules is less than or equal to X, the fault UPS modules can be changed online without affecting the UPS running.

6.1 Options supplied by the N+X parallel redundancy system

The 3A3 Pro UPS can be installed from 1 up to 10 3A3 Pro UPS modules in its cabinet and the user can choose the N+X parallel redundancy solution easily. Suppose the load is 25kVA and the optional solution is listed in the following table:

N+X	Permitted Maximum Power		Permitted Quantity of the Fault UPS Modules
	Apparent Power (kVA)	Active Power (kW)	
2+0	30	27	0
2+1	30	27	1
2+2	30	27	2
2+3	30	27	3
2+4	30	27	4
2+5	30	27	5
2+6	30	27	6
2+7	30	27	7
2+8	30	27	8

Note:

1. The “Permitted Maximum Power” does not mean that the UPS will be overloaded if this power value is exceeded. For example, when selecting the 2+2 configuration, the rated UPS apparent power is 60kVA and active power is 54kW, therefore, if load exceeds the permitted maximum power 27kW (permitted maximum power), the UPS will not be overloaded and only the N+X (X=2) structure will be changed.
2. The “permitted maximum power” indicates the three-phase power, so the permitted maximum power of single-phase needs to be divided by three.

6.2 Adding, reducing and changing the UPS modules online

The 3A3 Pro UPS module is hot swappable, and when performing adding, reducing or changing the UPS modules online, the operating instructions must be strictly followed.

1. Removing the UPS Module Online

- 1) set the position lock located on the front panel of the module to “” (see Fig. 6-2) and Set the input breaker of the UPS module rear to OFF position.
- 2) Two people each hold the handles located on the front panel of the UPS module with one of their hands and support the bottom of the module with the other hand respectively and they both use their strength together to draw the module outward smoothly and slowly until it is out, and then support it together and put it on the ground or some other temporary supports gently.

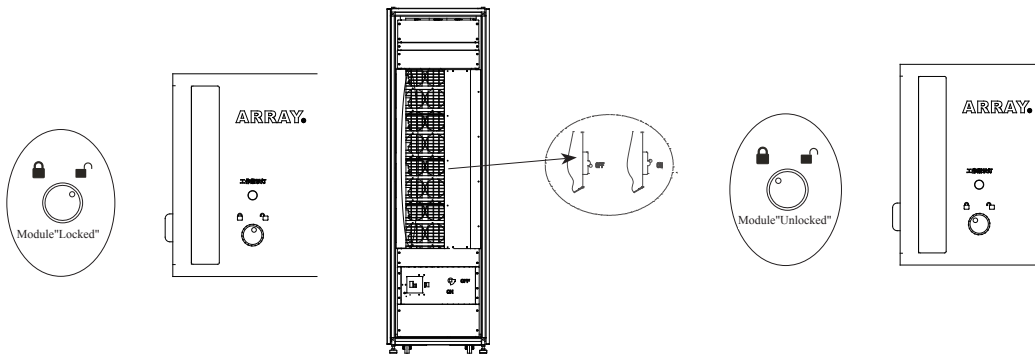



Fig. 6-1

Fig. 6-2

Fig. 6-3

2. Adding the UPS Module Online

- 1) Remove the cover plate located in the position where the module will be installed.
- 2) Two people each hold the handles located on the front panel of the UPS module with one of their hands and support the bottom of the module with the other hand respectively and slide the module into the bay of the frame together.
- 3) Set the position lock located on the front panel of the module to “” (see Fig. 6-3).
- 4) The input breaker of the module rear to ON position. (see Fig. 6-2).
- 5) If you add a UPS module in line mode, the new module will work in the parallel system automatically; while if you add a UPS module in battery mode, the new module will not build a power supply nor work in the parallel system until you have completed the above four steps and turn on the cold start switch.

Chapter 7 Operation

7.1 LCD Interface

LCD screen is located in the front of the cabinet. Touch screen allows users to operate the UPS easily. The LCD display is shown as the following two sections: UPS status bar and data display space. The UPS status bar provides the basic UPS status information for users by different colors; while the data display space provides the detailed UPS information for users through the LCD screen.

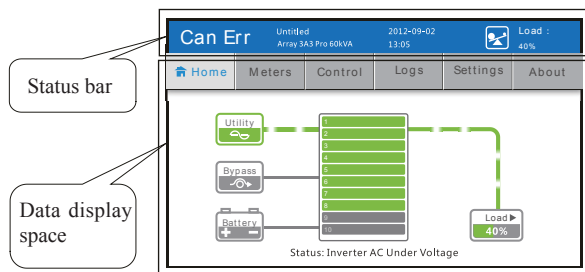

Fig. 7-1

7.1.1 Status bar



Fig. 7-2

- ① System status:
Display the current machine status.
- ② Machine name:
It is defined by users. If the user has several cabinets, they can be distinguished by setting names.
- ③ Machine model and capacity:
Model: Array 3A3 xxKVA; capacity is automatically displayed depending on the number of modules
- ④ System time:
Display the system time in the Communication service board (CSB)
- ⑤ Meters information:
Display information on the following three Meters: output voltage and frequency, load and battery capacity. Under normal circumstances, only the output voltage and frequency as well as load are displayed, with a scrolling interval of 3s. If the system turns to the battery mode and the battery capacity is low, only the battery capacity is displayed without scrolling and displaying other information.

Color of status bar:

Color	Description
Blue	The modes that the system is in: Shutdown, Standby, Normal, Converter, Battery (sufficient battery capacity) and Battery Test(sufficient battery capacity)
Orange	The modes that the system is in: Bypass, Battery (low battery capacity) and Battery Test(low battery capacity)
Red	System in Fault mode; the status bar is flashing between red and light blue. Click the exclamation mark to enter the current event interface and view the status information.

7.2 Startup

Note: check whether the input, output and the battery cables are connected correctly before turning on the UPS, if not, refer to the instruction and reconnect the cables. Do not perform the following operation until you make sure that the cables are connected properly.

1. Turning on the UPS in normal condition (the utility power is normal and the battery is dispensable)

1) Push the input breaker located on the back of the UPS to ON position (see Fig. 7-2).

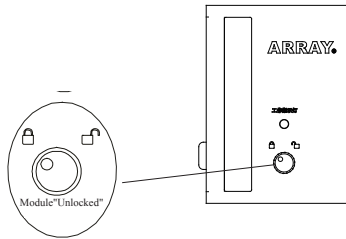

Fig. 7-3

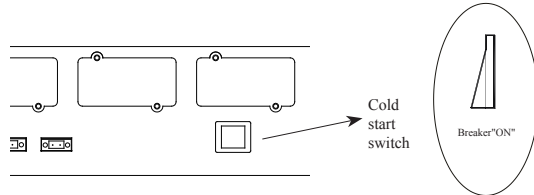



Fig. 7-4

2) Check the position locks located on the front panel of the installed UPS modules. Make sure that all of them are in the “” position and set the input breakers of all the installed UPS modules to ON position (see Fig. 7-3).

3) Set the battery breaker to ON position (external breaker).

4) Set the line input breaker (external) to ON position.

5) If the system is started up with no utility power, the “Cold Start Switch” (Fig. 7-4) on the communication interface needs repeatedly powering on and off. After the system is connected by cold start for about 1min, it automatically enters the Home.

① Enter the Home and click the “Control” button to enter the login interface. Type the correct control password or user password, click the ENTER key and then click the “Enter” button to enter the system control interface;

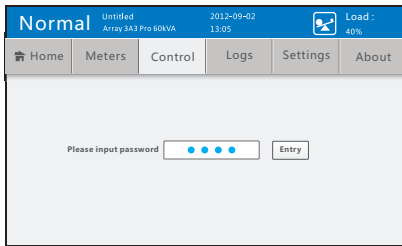

If the control password is set to the enabled status, the password is required to enter the system control interface. The default control password and user password are 1111 and 1234 respectively.

If the control password is set to the disabled status, click the “Control” button on the Home menu bar to directly enter the system control interface.

② On the system control interface, click the “Start” button to pop up a confirmation prompt box. After clicking OK, if the system meets the startup conditions, the startup is successful and the startup button turns to green.

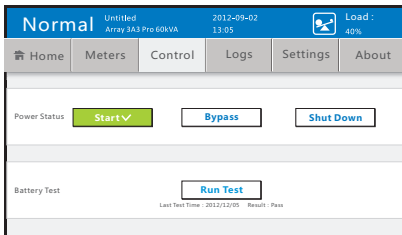

If the system fails to meet the startup conditions, the prompt box will be popped up to show message on operation prohibited as follows:

Button	Message on operation prohibited
Startup	1. No UPM or UPM has no power,cannot go Online!
	2. EPO is active,cannot go Online!
	3. UPM is unlock or switchgear is open,cannot go Online!
	4. Maintenance cover is open,cannot go Online!

7.3 Turning off the UPS

① Enter the Home and click the “Control” button to enter the login interface. Type the correct control password or user password, click the ENTER key and then click the “Enter” button to enter the system control interface;

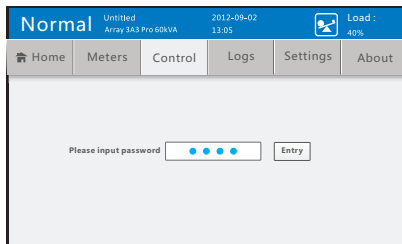

If the control password is set to the enabled status, the password is required to enter the system control interface. The default control password and user password are 1111 and 1234 respectively.

If the control password is set to the disabled status, click the “Control” button on the Home menu bar to directly enter the system control interface.

② Select “Bypass”, and then the bypass supplies power to the load. The “Bypass” button turns to orange.

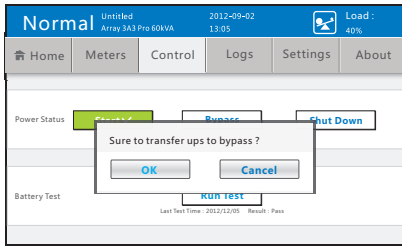

If the system fails to meet the startup conditions, the prompt box will be popped up to show the message on operation prohibited as follows:

Button	Message on operation prohibited
Shutdown to bypass	1. Bypass is forbidden on Converter Mode!
	2. Bypass is abnormal,cannot go to Bypass!

③ Select “Shut Down”, and “UPS is already shutdown” is displayed after 10s. If the system is in the shutdown status and click the Shutdown button, the prompt box will show that “UPS is not running!”.

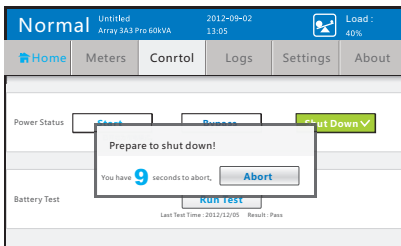

Chapter 8 Menu Commands

8.1 Function description on menu commands

Menu list	Description
Home	Display the menu bar and system status simulation diagram.
Meters	Used for viewing the meters types: System Meters, Module Meters and Battery Meters.
Control	Provides power control command. Control the Startup, Shut Down of UPS and Battery Test.
Logs	View the current and historical UPS alarm fault information through “Logs”, and the historical logs can be cleared.
Setting	Used for UPS setting and maintenance.
About	Used for users and maintenance personnel to view the software version numbers of all modules and system information; and also provide the maintenance time remainders.

Submenu item		Function description	
Meters	System Meters	Display the three-phase input/bypass/output voltage and frequency meters.	
	UPM Meters	Display the current status of each module. The status corresponding to module color is in accordance with that shown in the Home.	
	Battery Meters	Display the status, voltage, current and capacity of positive and negative batteries. Set battery current detection as disable in “Setting”à”Service” à”Battery Configuration”, then there is no content of battery current displayed in Battery Parameter Interface.	
Control	System Control	Switch the operation status of UPS system and perform the battery test, such as Startup, Shut Down and Switching to Bypass, Shut Down and Battery Test.	
Logs	Active Event	Display the information on Active Event, Including Event ID, Name and Type.	
	System Logs	Display the information on System Logs, Including Time, Event ID, Name, Source, Type; Service Password is required to enter it.	
	Clear LLgs	Entering service password can clear all the event logs.	
Setting	Configuration	Language Selection	Set the language type: simplified Chinese and English.
		Machine Name	The name is set not more than 14 characters. The keyboard is a system built-in text keyboard.
		System tTime	Set the date and time displayed on LCD panel of UPS system.
		Battery Test	Obtain the battery information via the battery test.
		Screensaver Time	Set the screensaver time. When it is out of the set range with no actions, turn off the backlight and enter the screensaver status.
		Light Test	Undergo the light test.
		LCD backlight	Set the brightness of LCD backlight.

Submenu item		Function description	
Setting	Configuration	Control Password	Set the control password to disable or enable status and change the password.
		Configuration Password	Set the configuration password to disable or enable status and change the password.
		Service Phone	Set the customer service telephone number, max. 13 numbers.
	Service	Battery Setting	Battery configuration: set the battery model, group number, number, temperature compensation, battery current detection. These can be undergone only under the Standby Mode or Bypass Mode.
			Battery charge: By opening or closing chargers for 10 modules, control the charging current.
			Battery discharge: set the low voltage alarm value when the battery is discharging (Voltage of a single battery: 10.5~11.3V). It can be undergone only under the Standby Mode or Bypass Mode.
		Output Setting	Set the output voltage and output frequency of the system. 1. They can be set only under the Standby Mode or Bypass Mode; 2. If the system is set to the Converter Mode, do not set the frequency.
		Bypass Setting	Displays the current or post-setting upper and low limit voltages for bypass. This setting can be undergone only under Standby Mode or Bypass Mode.
		System Mode	Set the System Mode. The Normal Mode and Converter Mode are optional.
		Minislot Baudrate	CSB panel has three slots for smart card. The baud rates for these three slots can be set.
		Service Teminder	UPS provides regular maintenance reminder service via the automatic timing function since the installation and use date, including over warranty reminder and maintenance reminder.
		Installation Time	Set the installation time in the format of YYYY-MM-DD.
		Resetting Password	Reset the control password, configuration password and unlock the XCP burning. After resetting, the control password and configuration password are default to be disabled. The XCP burning will be re-locked after unlocked for 30 min.
		Exporting Logs	Export the saved historical logs to USB device, which can save up to 10,000 logs.
		Other Messages	Displays BUS voltage and battery temperature.
About	User Information	Displays the details in the “setting” item.	
	Version Information	Displays the module version.	
	Service Information	Displays the dates for over-warranty information, maintenance reminder and installation.	

Note: The following menu screen and settings are for reference only. They are subject to change without notice.

8.2 Home

The Home contains two sections: menu bar and system status simulation diagram.

The simulation diagram is divided into three parts as follows: system power supply status, UPS module status and load status.

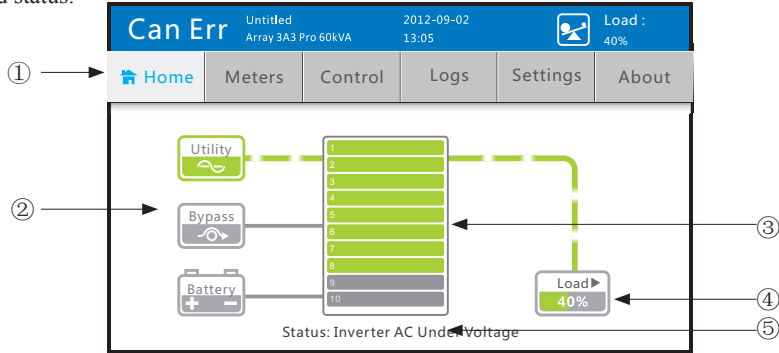
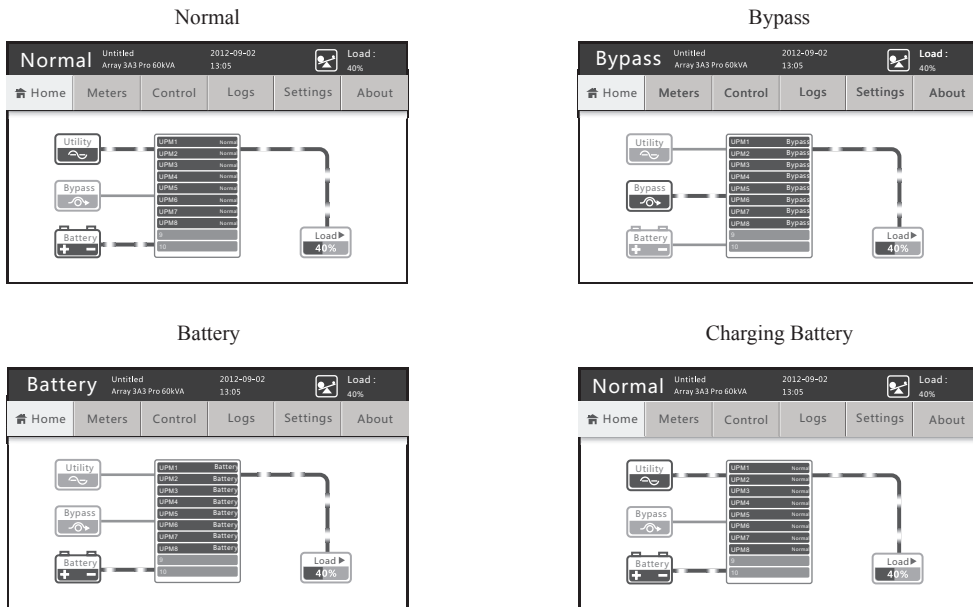

Fig. 7-5

① Menu bar

Single clicking the menu bar allows to enter the corresponding interfaces to view, control and set the system status. The menu bar consists of Home, Parameter, Control, Logs, Setting and About.

② System power supply status



Icon	Description
Utility power	<ol style="list-style-type: none"> When the utility power is normal, the icon lights; when the utility power is abnormal, the icon darks. When the utility power supplies power for the system, the flow diagram for utility power circuit is displayed. By clicking this icon, it can turn to system parameter interface to view the input information.
Bypass	<ol style="list-style-type: none"> When the bypass is normal, the icon lights; when the bypass is abnormal, the icon darks. When the system is in bypass status, the flow diagram for bypass circuit is displayed; otherwise, the flow diagram for bypass power supply will be disappeared. By clicking this icon, it can turn to system parameter interface to view the bypass information.
Battery	<ol style="list-style-type: none"> When the batteries are connected, the icon lights; and when the batteries are unconnected, the icon darks. When the batteries supply power for the system, the flow diagram for battery circuit is displayed with the current flowing: batteries -> UPS. When the system is charging the batteries, the flow diagram for battery circuit is displayed with the current flowing: UPS -> batteries. By clicking this icon, it can turn to battery parameter interface to view the battery information.

③ UPS module status

The statuses for each UPS module can be displayed, with a maximum of 10 module icons shown. When the module is in different status, the color of icon will be changed with text explanation. The meanings for the module icon colors are specified as follows:

Color	Meaning	Remarks
Grey	Not insert module or the module status being unknown	Click any position of the UPS, it can turn to the module parameter interface, in convenience of viewing each module status.
Light blue	Module being in Standby, Shut Down and Other Modes	
Green	Module being in Utility, Converter, Battery, Battery Test and Other Modes	
Orange	Module being in Bypass Mode	
Red	Module being in Fault Mode	

④ Load status

When the UPS is loading, its output circuit will be displayed as a flow diagram; otherwise, the output circuit will be grey. By single clicking the load icon, it can turn to the system output parameter interface to view the detail load information. The percentage of the total load for system is shown by numbers and scale bar.

⑤ System alarm

At the bottom of Home, the alarm information for system will be displayed in real time. When the system has several alarms, the alarm information will be scrolled.

8.3 Parameter

① Click the “Meters” icon on the Home menu to enter the parameter interface.

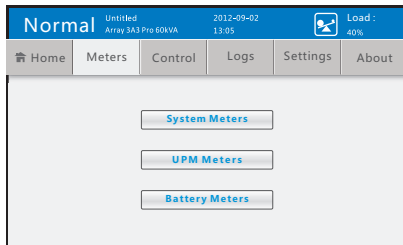

③ Click the “UPM Meters” to enter the module meters interface. If this interface is accessed by clicking the UPS icon on the Home, it will directly return to the icon when exiting.

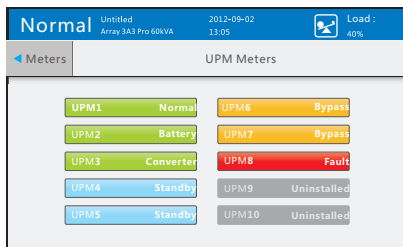

② Click the “System Meters” to enter the system meters interface. If this interface is accessed by clicking the “Normal” or “Bypass” icon on the Home, it will directly return to the Home when exiting.

The screenshot shows the System Meters interface with a table of data:

		Voltage(V)	Frequency(Hz)
Input	A	218.5	47.5
	B	218.5	47.5
	C	218.5	47.5
Bypass	A	218.5	47.5
	B	218.5	47.5
	C	218.5	47.5
Output	A	220.2	50.2
	B	220.2	50.2
	C	220.2	50.2

④ Click the “Battery Meters” to enter the battery meters interface. If this interface is accessed by clicking the “battery” icon on the Home, it will directly return to the Home when exiting.

a. battery current and backup time disable

The screenshot shows the Battery Meters interface with a table of data:

	Status	Voltage (V)	Capability (%)
Positive Battery	Disconnected	220.2	90%
Negative Battery	Disconnected	220.2	90%

b. battery current enable , backup time disable

The screenshot shows the Battery Meters interface with a table of data:

	Status	Voltage (V)	Current (A)	Capability (%)
Positive Battery	Disconnected	220.2	45.0	90%
Negative Battery	Disconnected	220.2	45.0	90%

c. battery current disable, backup time enable

	Status	Voltage (V)	Capability (%)	Backup (min)
Positive Battery	Disconnected	220.2	90%	35
Negative Battery	Disconnected	220.2	90%	35

d. battery current and backup time enable

	Status	Voltage (V)	Current (A)	Capability (%)	Backup (min)
Positive Battery	Disconnected	220.2	45.0	90%	35
Negative Battery	Disconnected	220.2	45.0	90%	35

8.4 Control

① Click the “Control” icon on the Home menu to enter the login interface. The control password or user password or service password is required to enter the system control interface. The default control password and user password are 1111 and 1234 respectively.

Please input password

The “Control password” can be replaced by the “User password” or “Service password”.

The “User password” can be replaced by the “Service password”.

② If the password is correct, enter the “System Control” interface.

Power Status:

Battery Test:

Last Test Time : 2012/12/05 Result : Pass

The “System Control” interface has these buttons of “Startup, Shutdown to bypass, shutdown and Run Test”. The colors for the lighted buttons of Startup, Shutdown to bypass and shutdown are respectively green, orange and red. See chapters 7.2 & 7.3 for details.

③ Click “Battery Test” to pop up a confirmation prompt box.

Sure to run battery test ?

④ If the system is not under the Normal Mode or Converter Mode, the prompt box will be popped up to show “Please carry out battery test in Normal or Converter mode!” Make sure if the UPS is on the Normal mode or Converter Mode at the status bar; Otherwise enter the control interface and do test after startup.

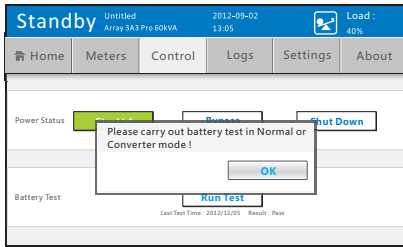

8.5 Logs

① Click the “Logs” icon on the Home menu to enter the Logs interface.

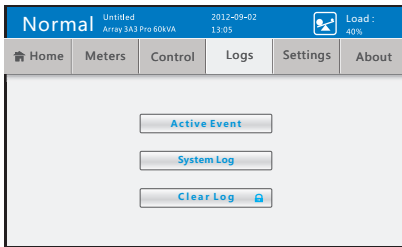

② Click the “Clear Log” and type the service password to enter the clear logs interface.

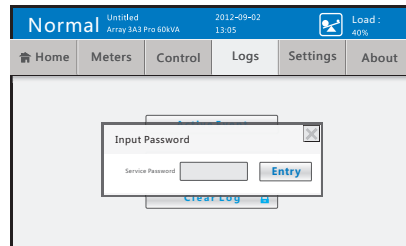

③ Click the “Active Event” to enter the Active event interface. Please refer to the following list for details.

ID	Event	Source	Type
1			
2			
3			
4			

Item	Description
Event ID	Event ID number. Displayed from 0 to 65535
Event name	Details for this event
Event type	Status, Commands, Reminder and Alarm
Source	Module where event occurs

④ Click “System log” and type the service password to enter the System logs interface. Please refer to the following list for details.

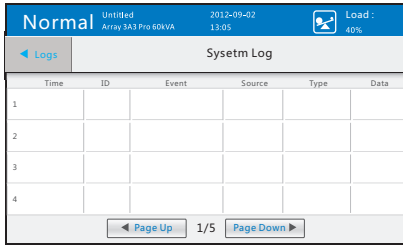

Item	Description
Time	Occurred time in the form of YYYY/MM./DD hh: mm: ss; xxx; xxx is millisecond.
Event ID	Event ID number. Displayed from 0 to 65535
Event name	Details of this event
Event type	Status, Commands, Reminder and Alarm.
Source	Module where event occurs, including CSB and UPM1~UPM10.
Data	The recorded data. Displayed from 0 to 65535

8.6 Setting

① Click the “Settings” icon on the Home menu to enter the Setting interface. The configuration items are intended for customers, while the service items are for the customer service and maintenance personnel.

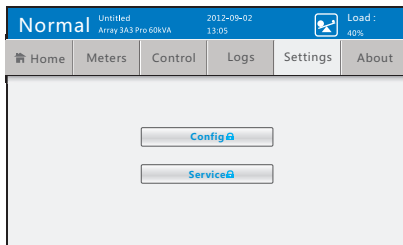

② Click “Config” and type the correct password to enter the Configuration interface.

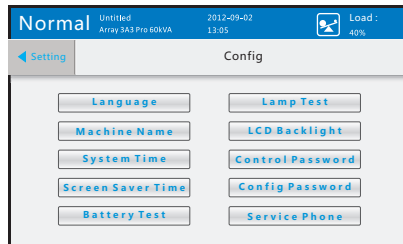

③ Click “Service” and type the correct password to enter the Service interface.



8.6.1 Configuration

① Enter the “Language” interface. The Current language button is in blue and other in off-white.

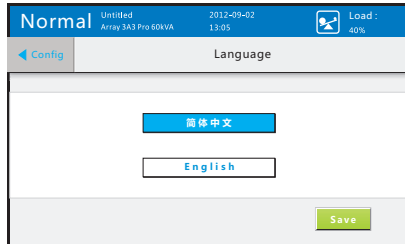

② Enter the “Machine Name” interface. Users set the machine name, which is not more than 14 characters.

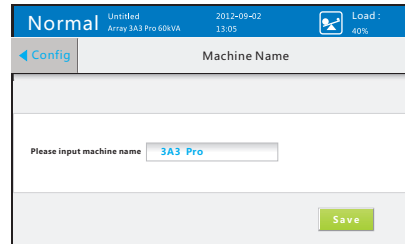

③ Enter the “System Time” interface to set the system time.

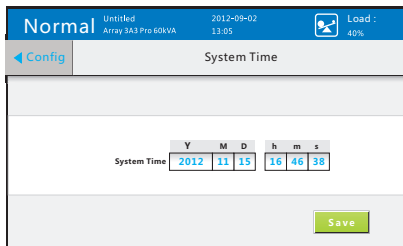

④ Enter the “Battery Test” interface to set the time for battery test. The range is to be set between 0 and 9000s. The default self-test time is 10s.

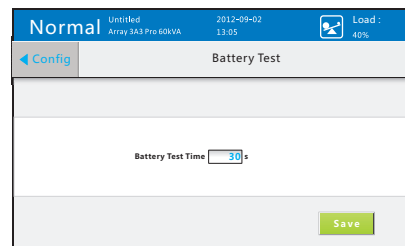

⑤ Enter the “Screen Saver Time” interface to set the Screensaver time. The range is to be set between 10 and 60min.

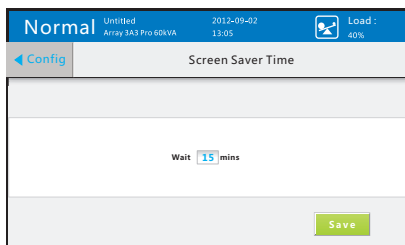

⑥ Enter the “Lamp Test” interface to do the light test.

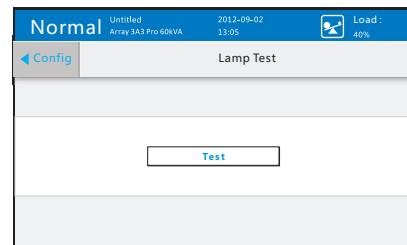

⑦ Enter the “LCD Backlight” interface to set the backlight brightness. The range is to be set between 1% and 100%.

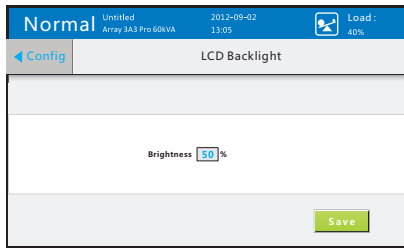

⑧ Enter the “Control Password” interface to set the control password to be enabled or disabled and the password change function.

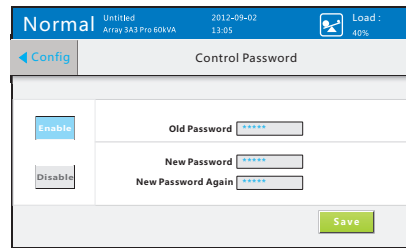

⑨ Enter the “Config Password” interface to set the configuration password to be enabled or disabled and the password change function.

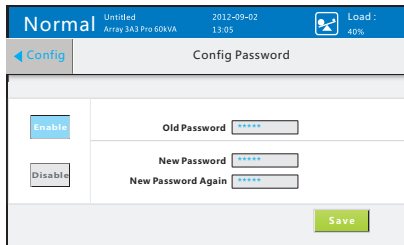

⑩ Enter the “Service Phone” interface to set the telephone number for customer service, which should be not more than 13 characters.

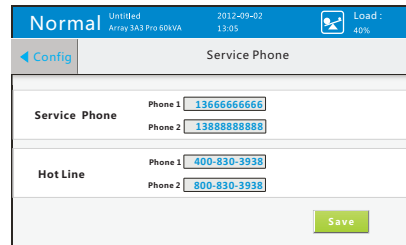

8.6.2 Service

① Enter the “Battery” interface to set the battery configuration, charge and discharge.

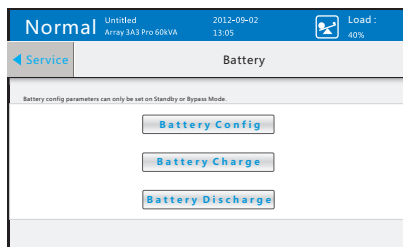

② Enter the “Battery Config” interface to set the battery configuration.

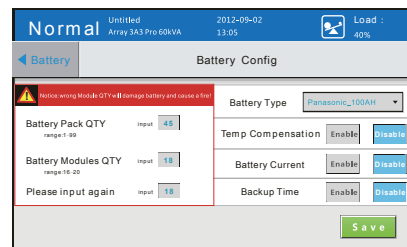

② Enter the “Output” interface to set the output voltage and frequency for the system.

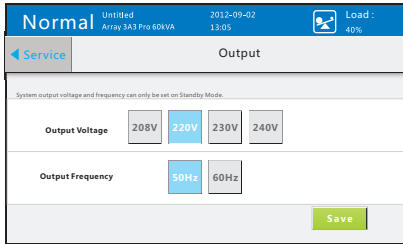

③ Enter the “Bypass” interface to set the upper and lower limit voltage.

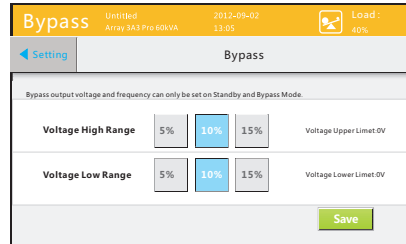

④ Enter the “System Mode” interface to set the system mode.

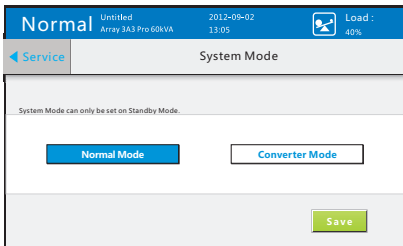

⑤ Enter the “Minislot Baudrate” interface to set the baud rate for the three slots.



⑥ Enter the “Service Reminder” interface to set the over-warranty reminder and maintenance reminder.

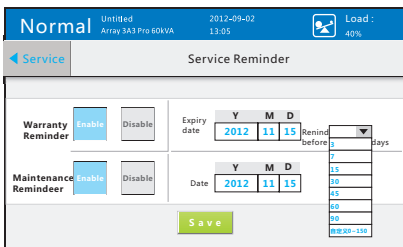

⑦ Enter the “Installed Time” interface to set the installation time.

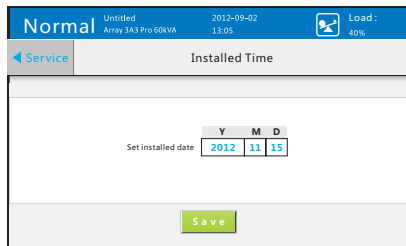

⑧ Enter the “Reset Password” interface to reset the passwords and unlock the XCP burning

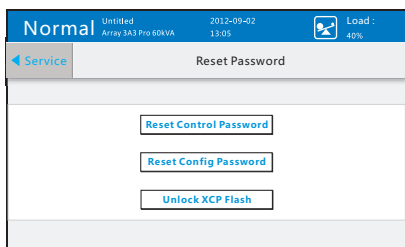

⑨ Enter the “Export Log” interface to export the historical logs to USB.

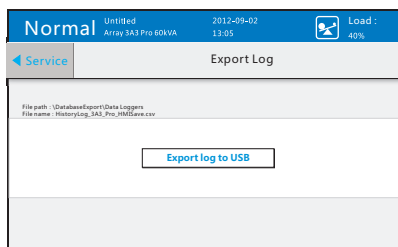

⑩ Enter the “Other Messages” interface to view the information such as BUS voltage.

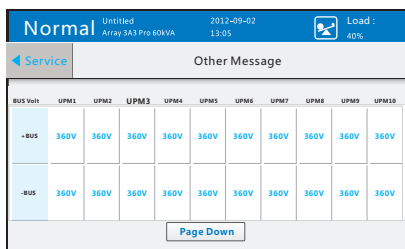

8.6 About

① Click the “About” icon on the Home menu to enter the About interface.

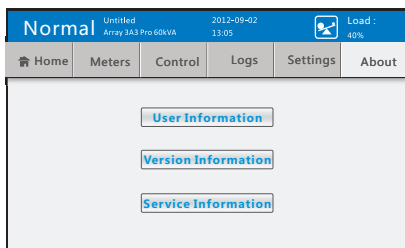

② Click the “User Information” to enter the User information interface.

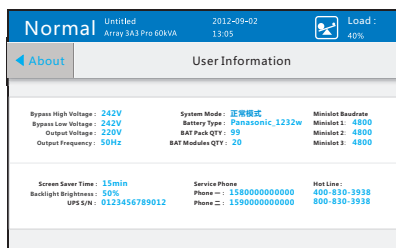

③ Click the “Version Information” to enter the Version information interface.

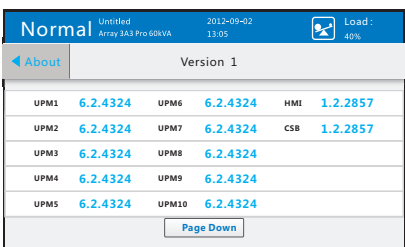

④ Click the “Service Information” to enter the Service information interface.

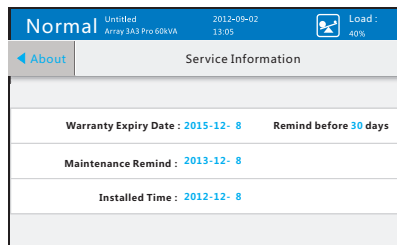

Chapter 9 Maintenance

9.1 Maintenance Notice

1. The UPS and battery maintenance should be performed by trained and qualified technical personnel.
2. For long-term inaction, the battery should be fully charged once every three months in normal temperature environment and once every two months in high temperature environment.
3. The rear part of the UPS consists of two parts, the upper part and the lower part. The maintenance bypass switch and output switch are located in the upper part, and do not operate the two breakers in normal condition, otherwise, it may cause the equipment to be powered off or hazards; the electrified copper bars and module input switches are located in the lower part. The door of the cabinet is locked. Do not attempt to open the door, otherwise, electric shock may occur.

9.2 Service Methods

If the UPS fails for unknown reasons, do not operate the UPS, contact the nearest service site or the distributor, or call customer service hotline at 400-889-3938 for advice.

9.3 Maintenance Bypass

Note: this function may only be performed when the equipment is powered off due to UPS fault. Do not attempt to operate the UPS until you read through the following operating procedure. Any questions, please consult the service site or the distributor firstly.

1. Operating procedure of transferring to maintenance bypass
 - 1) Open the “maintenance door” of the UPS cabinet (the door located on the rear upper part of the UPS cabinet).
 - 2) Pull the cover plate of the maintenance switch rightward to open it (see Fig 9-1).

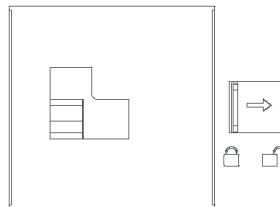

Fig. 9-1

Note: theoretically, the UPS shall transfer to bypass automatically. Please check the prompts shown on the LCD screen to make sure that the UPS has transferred to bypass. Otherwise, do not perform the next operation.

- 3) Set the maintenance switch to ON position (see Fig. 9-2).
- 4) Turn the UPS output switch to OFF position (see Fig. 9-3).
- 5) Set the input breakers of the UPS modules and the battery switch to OFF position.

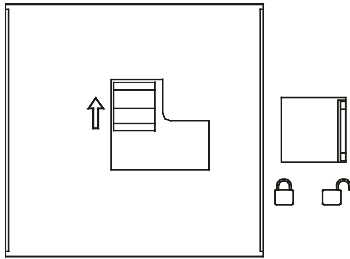

Fig. 9-2

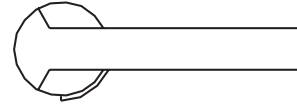
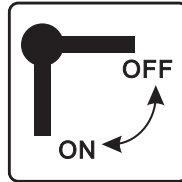
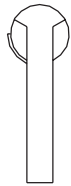
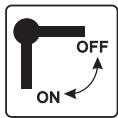

Fig. 9-3

2. Operating procedure of recovering from maintenance bypass

- 1) Set the battery switch and the input breakers of the UPS modules to ON position.
- 2) After all the UPS modules have transferred to the bypass mode, set the output switch of the UPS to ON position (see Fig. 9-4).



Output Switch

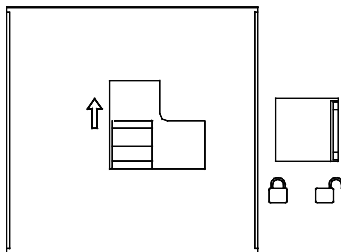

Fig. 9-5

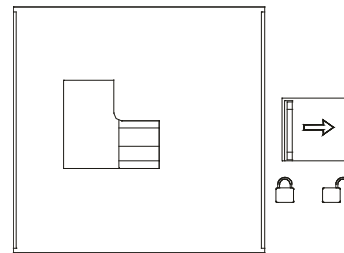

Fig. 9-6

- 3) Set the maintenance switch to OFF position (see Fig. 9-5).
- 4) Pull the cover plate of the maintenance switch leftward to close it (see Fig. 9-6).
- 5) Turning on the UPS through the LCD display and operation panel.

Chapter 10 Communication Interface

10.1 Communication Ports

The ARRAY UPS series provides Intelligent Slot, EPO and temperature detection port so that the user can monitor the UPS operation status by computer easily (see Fig. 10-1).

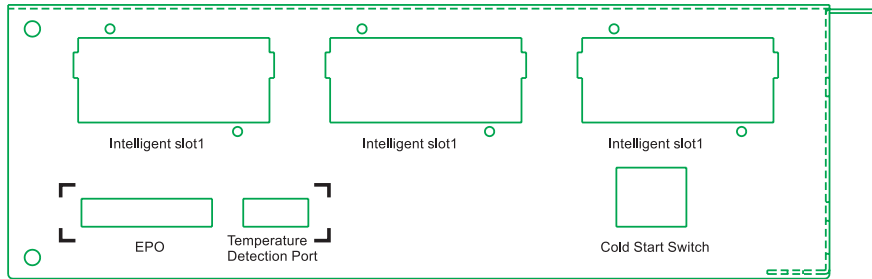

Fig. 10-1

10.2 EPO

The EPO (Emergency Power Off) switch is green and located at the right upper part of the rear panel, which is used to shut down the UPS from local or remote operation in case of any emergency.

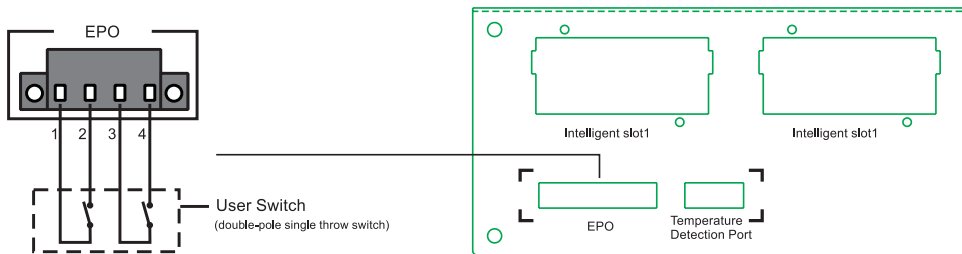

Fig. 10-2

Remark:

Connect 1-2 and 3-4: Emergency Power Off;
Others (including suspending): normal

10.3 Intelligent Slot

This series is equipped with three intelligent slots for maximum three intelligent cards supporting various communication ports such as RS232, USB, RJ45 and dry contacts etc.to realise remote supervising management on UPS.

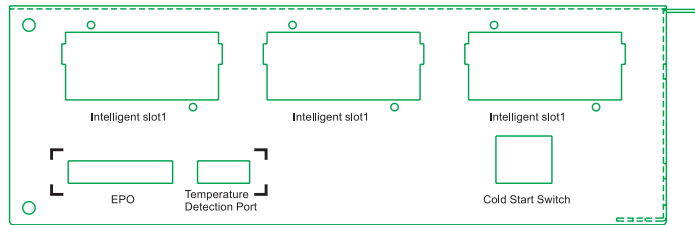

Fig. 10-2

This series is equipped with three intelligent slots, which are available for the following cards:

USB+RS232 Card: provides standard USB and RS232 communication ports, each kind of port is capable to monitor the UPS operation status.

AS400 Card: provides dry contact interface for UPS supervising, the contact signals can reflect the UPS operation status so as to realize power source management.

NMC Card: enables remote supervising management on UPS by accessing Internet.

CMC Card: operation status on UPS by MODBUS Software remote supervising .

Note:

1. There is no need to shut down the UPS when installing the intelligent cards.
2. Remove the cover plate prior to the installation, and keep it for future use.
3. The USB+RS232 card provides both USB and RS232 port, users may choose only one of them to connect with the PC.
4. Please refer to relevant information for the application of the WINPOWER software, USB+RS232 card, AS400 card, NMC card and CMC card. If there is any questions, please call the customer service center at 400-889-3938 for advice.

10.4 Battery Temperature Detection Port

Since the battery is sensitive to temperature, the temperature sensor connected to the battery temperature detection port is capable to detect any change of the battery temperature, Charging voltage can be automatically adjusted by UPM according to the temperature to avoid overcharge at high temperature or undercharge at low temperature and thus prolong the battery lifetime. There are two kinds of temperature sensor with different lengths: 5-meter and 2-meter; and users may purchase it from the distributor.

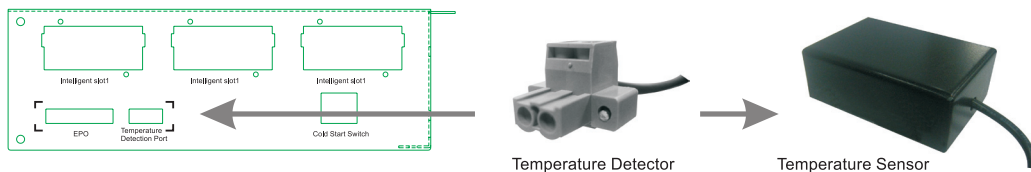

Chapter 11 Troubleshooting

Should the UPS fails during the first time installation or use, which may be caused by improper use. Please check if the installation, wire connection or application is done properly. If yes, then contact the customer service center and provide the following information:

1. MODEL and SERIAL NO of the UPS (on the rear panel of the unit or search them through LCD screen).
2. Information shown on the LCD screen and the LED status of the unit when the fault occurs.

Since there are some installation and operation limitations for the 3A3 Pro .UPS, please pay special attention to the “Note” part in this manual. Please refer to the troubleshootings listed below for common problems treatment.

11.1 Common problems on LCD display

Problem 1: the communication interface not run normally

Possible cause: the communication module is not fully engaged

Solution: draw out the communication module and push it into the bay completely again.

11.2 Common problems on UPS module

Problem 1: the slid module not be detected

Possible cause: the UPS module is not fully engaged

Solution: draw out the UPS module and push it into the bay completely again.

Problem 2: the latest added UPS module fails to be turned on

Possible cause: the position lock of the latest added UPS module is in the position of unlocking or the input breaker is in the position of OFF

Solution: set the position lock to the position of locking and set the input breaker in the position of ON

Problem 3: UPS fails to be powered from the utility

Possible cause: the input phase sequence is wrong, or the input voltage or frequency exceeds the specification range

Solution: check whether the utility power (mains) input voltage or frequency is normal; if the phase sequence is reverse, then correct it.

Problem 4: UPS module not be detected by LCD when starting the unit from DC

Possible cause: the power supply will be cut off automatically if there is no turn-on command received by the module within 30 seconds as soon as it builds a power supply, therefore, the problem may arise because the unit is not turned on in time.

Solution: turn on the unit within 30 seconds as soon as the UPS module builds a power supply

Problem 5: the parallel UPS works in bypass mode and fails to transfer to line mode

Possible cause: the cover plate of the maintenance breaker is not in the position of locking

Solution: set the cover plate of the maintenance breaker to the position of locking

Problem 6: during parallel operation, a blue LED indicator of a module flashes and the LCD display of the module flashes.

Possible cause: module internal fault

Solution: follow the procedure of removing a module online to draw out the module and slide into a new module, then follow the procedure of adding a module online to start the module.

11.3 Common Problems on Battery and charger

Problem 1: no charging voltage and charging current in line mode

Possible cause: battery is detected to be disconnected when starting the unit and the charger is shut down

Solution: select the battery self-diagnosis on the LCD panel. The charger will start up automatically after the the battery is detected.

Problem 2: the battery self-test fails although the battery exists.

Possible cause: the battery breaker is not in the position of ON or the battery is damaged.

Solution: check the battery breaker. Replace the battery if it is damaged.

Chapter 12 Product Specifications

12.1 Electrical Specification

12.1.1 Input:

Wiring: Three phase + N + Ground

Voltage: 124-300VAC (phase to phase); 214-520VAC (line to line)

Frequency: 40-70Hz

Power factor: ≥ 0.99

Bypass voltage range: 187-253VAC (phase to phase); 323-437VAC (line to line)

12.1.2 Output:

Wiring: Three phase + N + Ground

Voltage: $380 \times (1 \pm 1\%)$ VAC

Power factor: 0.9

Frequency tolerance: $50 \times (1 \pm 0.5\%)$ Hz (in line mode); $50 \times (1 \pm 0.5\%)$ Hz (in battery mode)

Overload time: ≥ 10 min ($110\% < \text{load} \leq 130\%$)

UPS efficiency: >Up to 94%

12.1.3 Battery rated voltage

Unilateral battery number of: 16/17/18/19/20

Positive battery voltage: +192VDC/+204VDC/+216VDC/+224VDC/+240VDC:

Positive battery charge current: $3.5A \times \text{Modules number}$

Negative battery voltage: -192VDC/-204VDC/-216VDC/-224VDC/-240VDC:

Negative battery charge current: $3.5A \times \text{Modules number}$

12.2 Noise

< 62dB

12.3 Operating Environment

Ambient temperature: 0-40°C

Ambient humidity: 20-90%

Altitude: ≤ 1000 m

Storage temperature: -25-55°C

12.4 Dimensions and net weights

Part Name	Dimension W×D×H (mm)	Net Weight (kg)
60kVA UPS cabinet with lower wire-outlet holes (2.0-meter tall)	600×1050×2030	200
90kVA UPS cabinet with upper wire-outlet holes (2.0-meter tall)	600×1050×2030	230
90kVA UPS cabinet with lower wire-outlet holes (2.0-meter tall)	600×1050×2030	230
120kVA UPS cabinet with upper wire-outlet holes (2.0-meter tall)	600×1050×2030	265
120kVA UPS cabinet with lower wire-outlet holes (2.0-meter tall)	600×1050×2030	265
150kVA UPS cabinet with lower wire-outlet holes (2.0-meter tall)	600×1050×2030	275
PDU	483×194×131	9
UPS module	440×707×131	35

Chapter 13 Warranty

The company warrants its products to be offered free warranty service for three years from the date of purchase.

To obtain service under warranty via an valid guarantee offered by distributors;
To obtain service under warranty via serial number.

The cost of delivery shall be borne by the customer, please contact the service center or distributor.

We provide the user with the following services:

Three-year warranty (including batteries purchased from the company);

24-hour toll-free hot line service: 400-889-3938;

Nationwide warranty;

Technical support on our web site;

Website: www.eaton.com/powerquality

E-mail: upsservice@eaton.com

This limited warranty does not apply to conditions as follows:

Man-made fault or out of warranty;

The finished product of which the serial number is changed or lost;

Damage or loss resulted from force majeure or external causes;

Disassembly or modifications to the unit with no authorization;

Disobeying provisions of operating/using the unit;

Battery over discharged or man-made damage.

Appendix 1: The reference table of LED indicators

No.	Working condition	LED Display				BUZZER
		Normal	Battery	Bypass	Fault	
1	Normal Mode / Converter Mode					
	No Alarm	●				
	Alarm	●			★	Beep every 4 seconds
2	Battery Mode					
	No Alarm	●	●			
	Alarm	●	●		★	Beep every 4 second
3	Battery Test					
	No Alarm	●	●			
	Alarm	●	●		★	Beep every 4 second
4	Bypass Mode / Maintenance bypass					
	No Alarm			●		
	Alarm			●	★	Beep every 4 seconds
5	Fault Mode					
	Bypass Output			●	★	Beep every 4 seconds
	No Output				★	Beep every 4 seconds

Should any display or warning message excluded in the above table be found, please contact the distributors or call the service hot line for advice.

● _LED indicator lighting

★ _LED indicator flashing

Note:

1. The event includes "NOTICE" and "ALARM". Only "ALARM" event will trigger Fault LED flashing and BUZZER.
2. Buzzer stops beeping and fault LED stops flashing once enters to "Logs"- "Active Event" screen.

Appendix 2: Battery configuration

The least number of the battery pack: the batteries with different capacity have different charging and discharging threshold. To maintain the battery's service life, please determine the number of the battery packs according to users' requirement and the following information.

The battery configuration table: the blank columns in the table indicate configuration prohibition and the filled columns indicate the permitted number of the battery packs.

1. 24Ah battery configuration table:

Battery Pack Power	24Ah*1	24Ah*2	24Ah*3	24Ah*4	24Ah*5	24Ah*6	24Ah*7	24Ah*8
15kVA								
30kVA								
45kVA								
60kVA								
75kVA								
90kVA								
105kVA								
120kVA								
135kVA								
150kVA								

2. 38Ah battery configuration table:

Battery Pack Power	38Ah*1	38Ah*2	38Ah*3	38Ah*4	38Ah*5	38Ah*6	38Ah*7	38Ah*8
15kVA								
30kVA								
45kVA								
60kVA								
75kVA								
90kVA								
105kVA								
120kVA								
135kVA								
150kVA								

3. 65Ah battery configuration table:

Battery Pack \ Power	65Ah*1	65Ah*2	65Ah*3	65Ah*4	65Ah*5	65Ah*6	65Ah*7	65Ah*8
15kVA								
30kVA								
45kVA								
60kVA								
75kVA								
90kVA								
105kVA								
120kVA								
135kVA								
150kVA								

4. 75Ah battery configuration table:

Battery Pack \ Power	75Ah*1	75Ah*2	75Ah*3	75Ah*4	75Ah*5	75Ah*6	75Ah*7	75Ah*8
15kVA								
30kVA								
45kVA								
60kVA								
75kVA								
90kVA								
105kVA								
120kVA								
135kVA								
150kVA								

5. 100Ah battery configuration table:

Battery Pack \ Power	100Ah*1	100Ah*2	100Ah*3	100Ah*4	100Ah*5	100Ah*6	100Ah*7	100Ah*8
15kVA								
30kVA								
45kVA								
60kVA								
75kVA								
90kVA								
105kVA								
120kVA								
135kVA								
150kVA								

6. 120Ah battery configuration table:

Battery Pack \ Power	120Ah*1	120Ah*2	120Ah*3	120Ah*4	120Ah*5	120Ah*6	120Ah*7	120Ah*8
15kVA								
30kVA								
45kVA								
60kVA								
75kVA								
90kVA								
105kVA								
120kVA								
135kVA								
150kVA								

